

LEGO

Disney PRINCE OF PERSIA
THE SANDS OF TIME

BUILDING STEPS!

PART 2

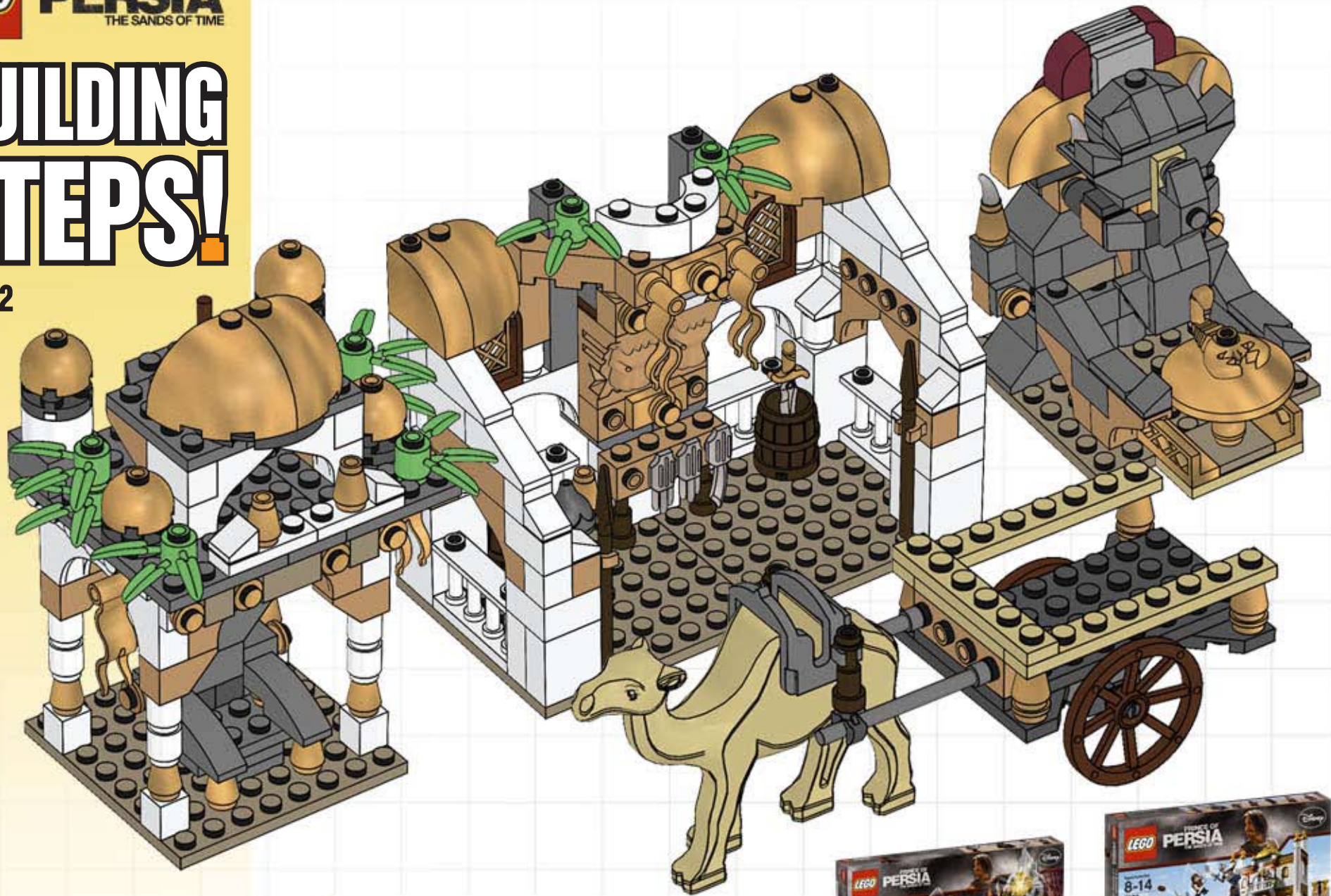

LEGO club

You can create an entire scene from the world of Prince of Persia: The Sands of Time by combining pieces from two LEGO® sets: 7572 Quest Against Time and 7573 Battle of Alamut!

© Disney Enterprise, Inc. and Jerry Bruckheimer, Inc.



7572



7573

LEGO® PRINCE OF PERSIA BUILDING STEPS!

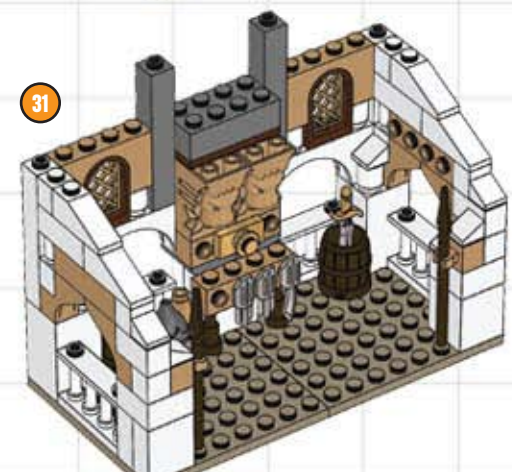
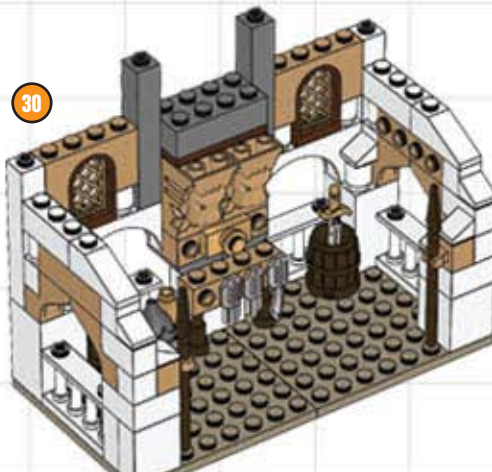
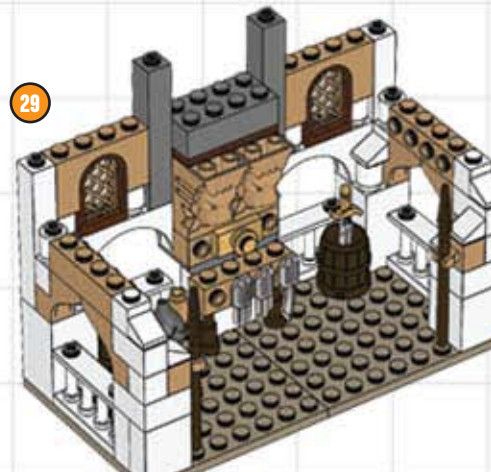
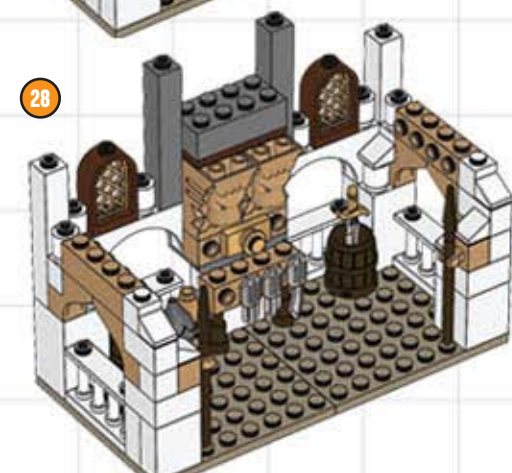
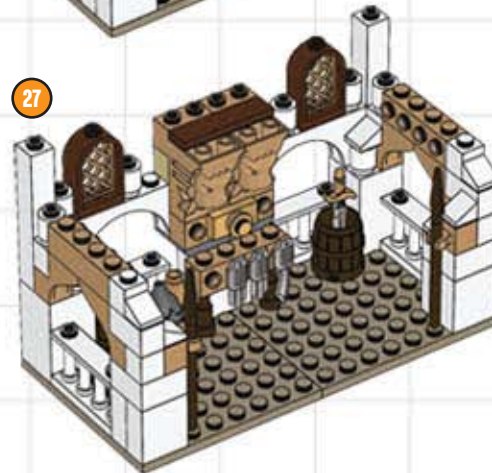
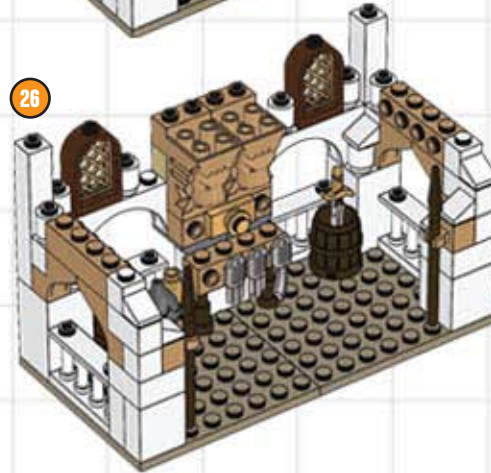
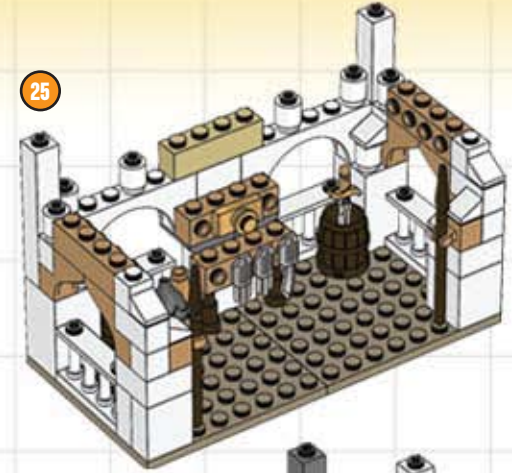
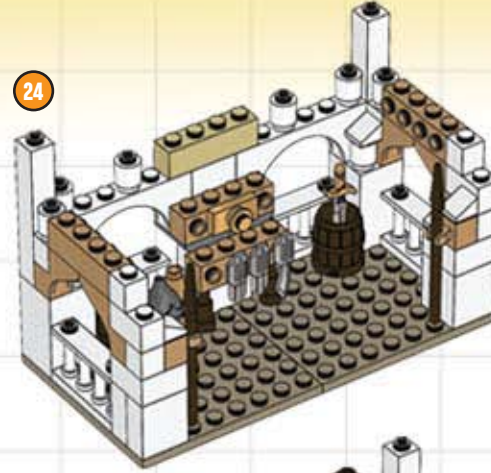
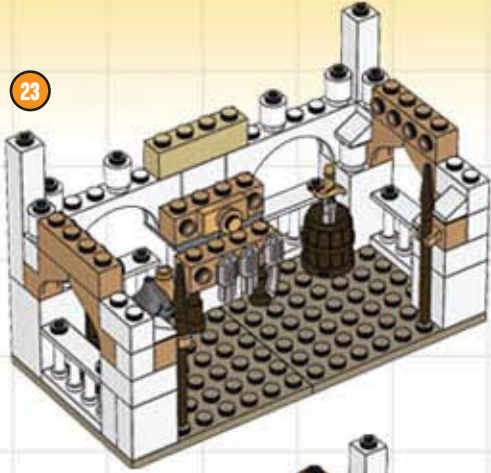

LEGO® PRINCE OF PERSIA BUILDING STEPS!

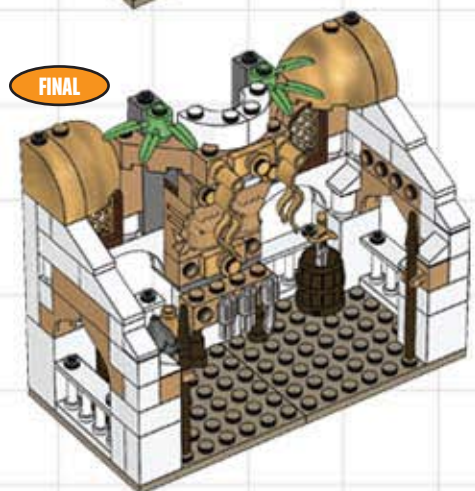
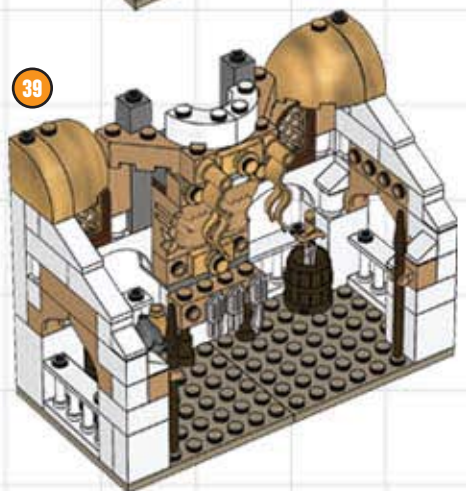
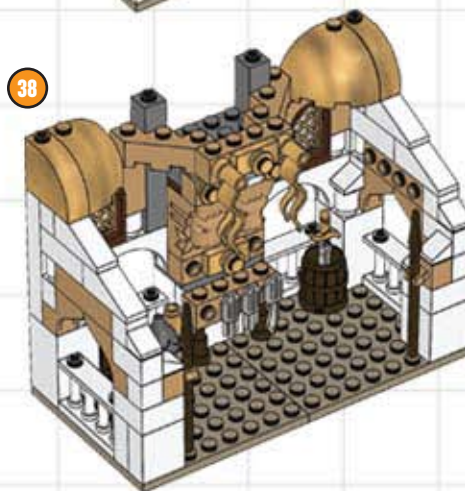
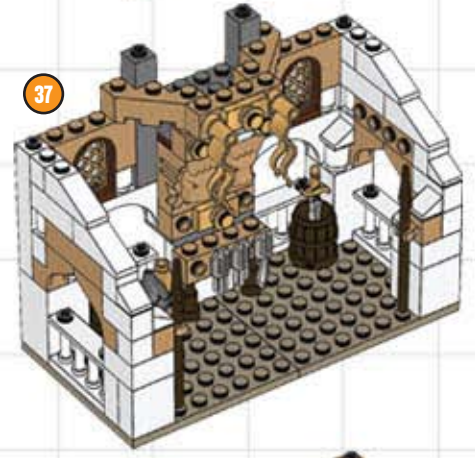
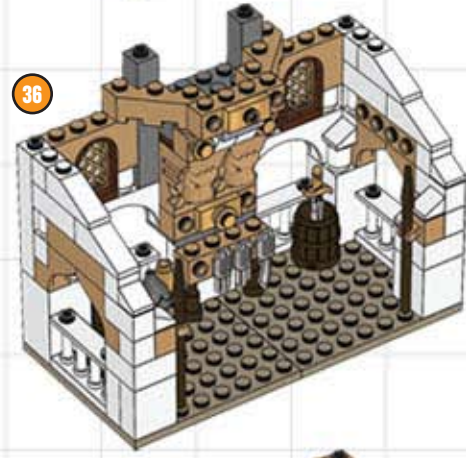
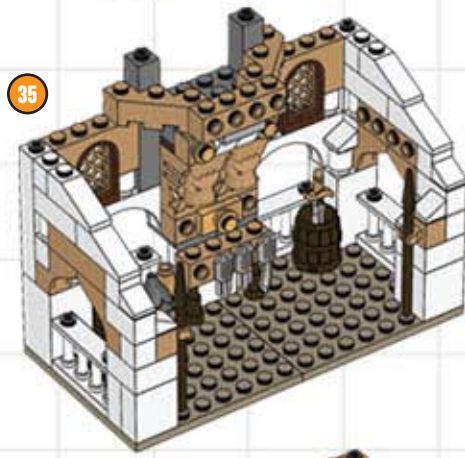
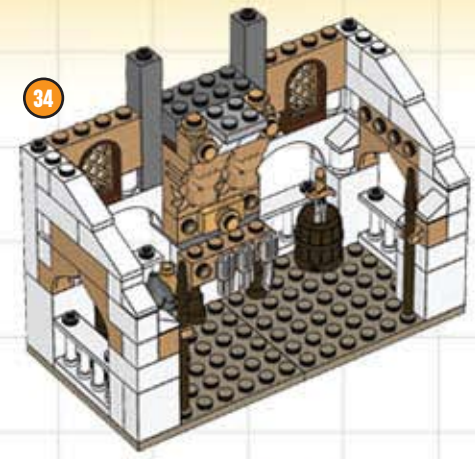
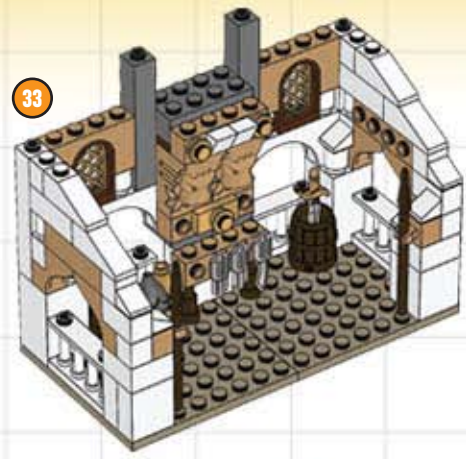
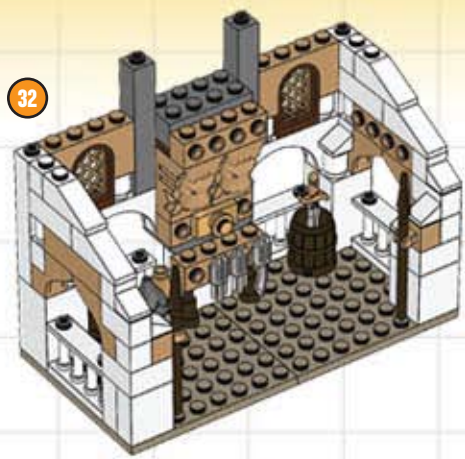

LEGO® PRINCE OF PERSIA BUILDING STEPS!

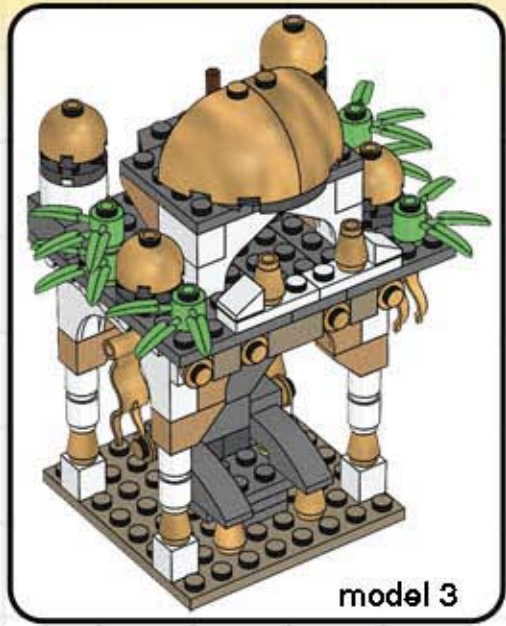

1



2



3



4



5

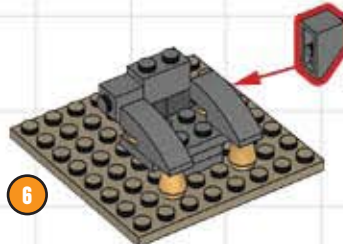

6

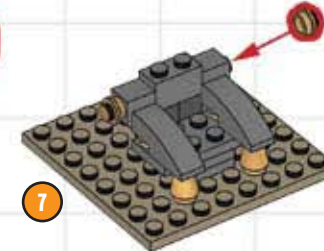

7

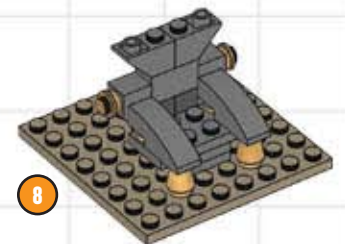

8

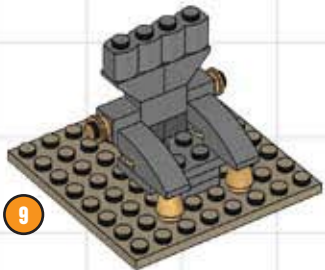

9



10

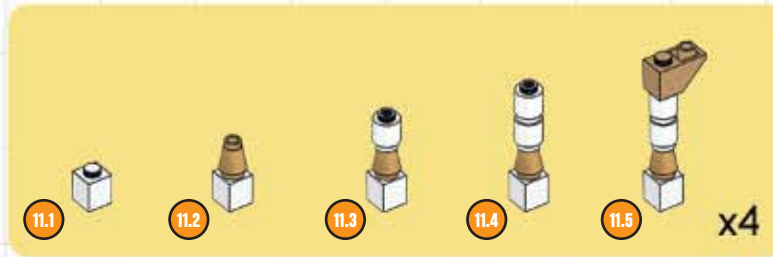

11.1

11.2

11.3

11.4

11.5

x4

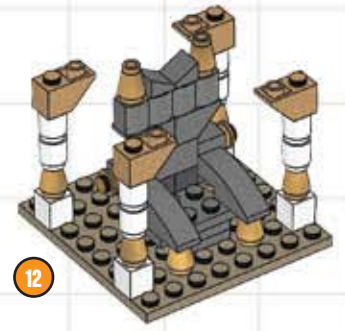

12

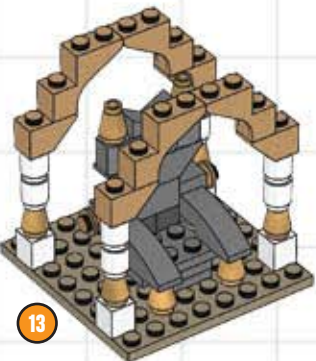

13

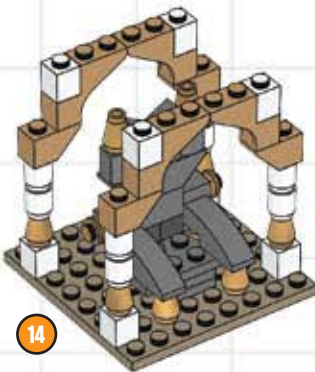

14

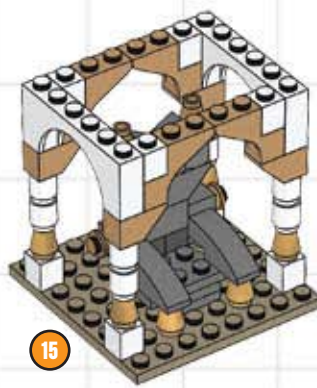

15

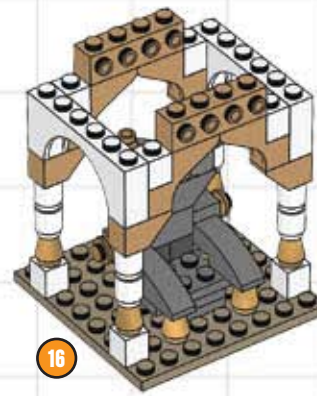

16

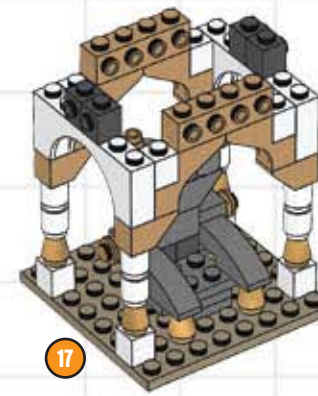

17

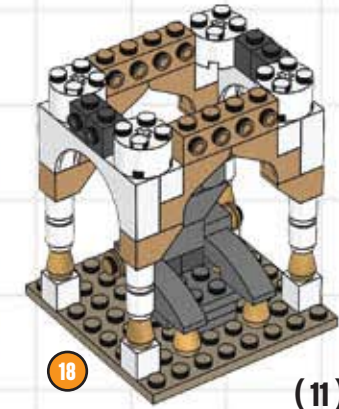

18

LEGO® PRINCE OF PERSIA BUILDING STEPS!

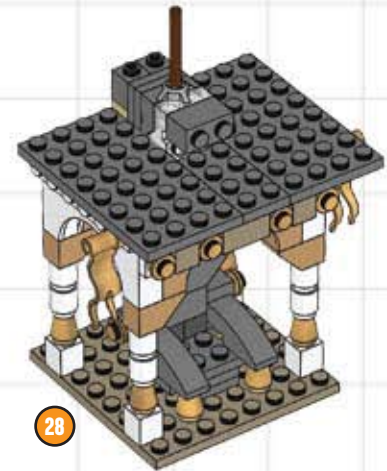
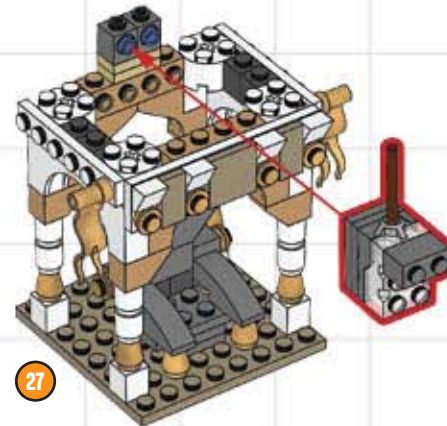
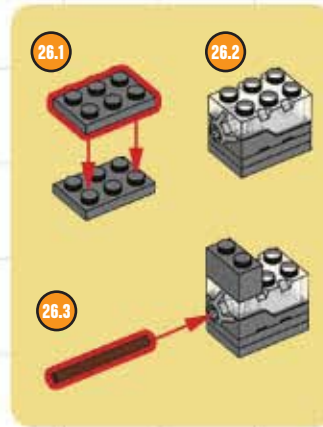
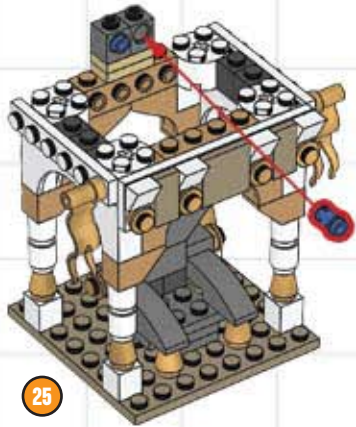
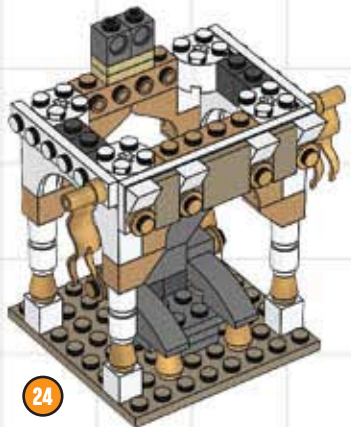
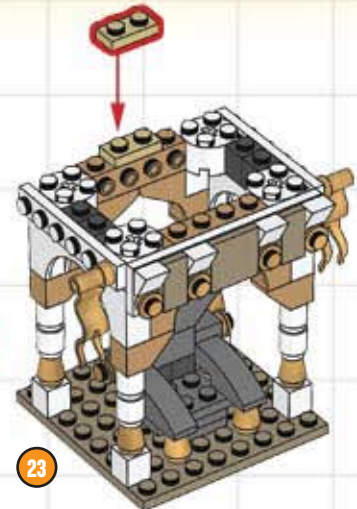
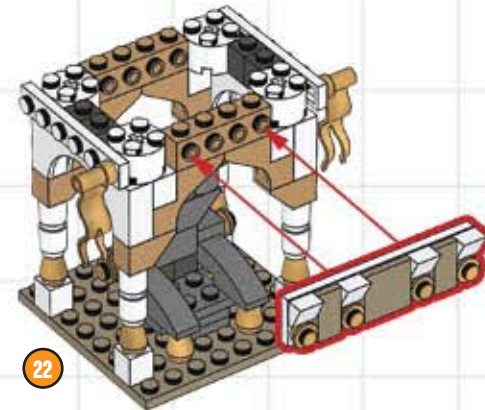
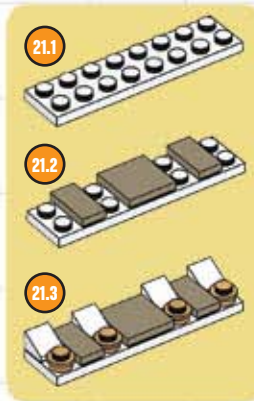
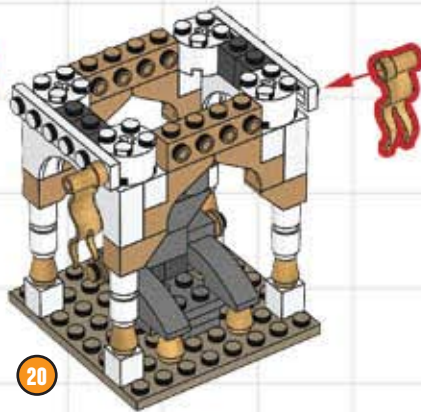
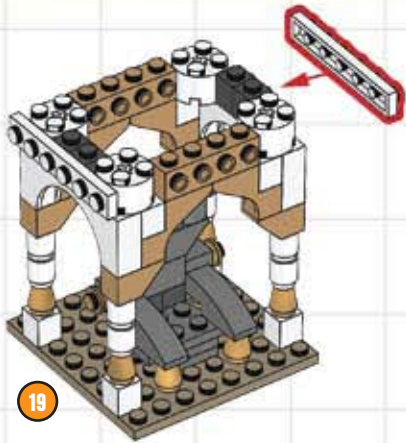

LEGO® PRINCE OF PERSIA BUILDING STEPS!

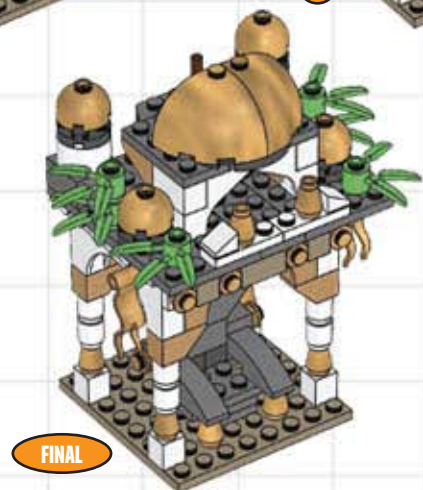
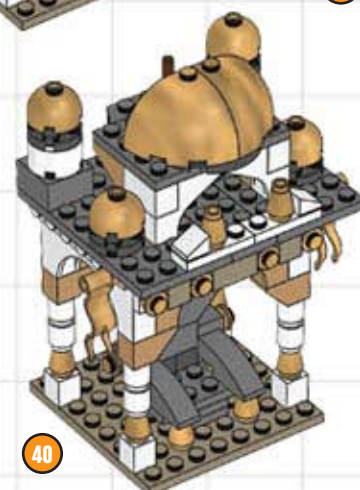
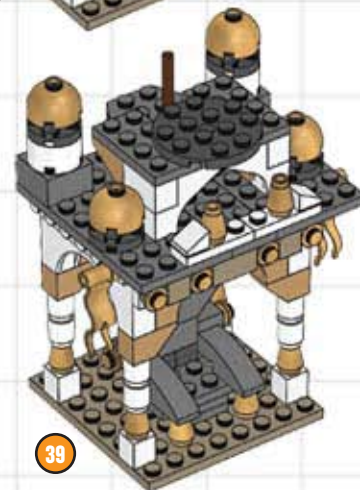
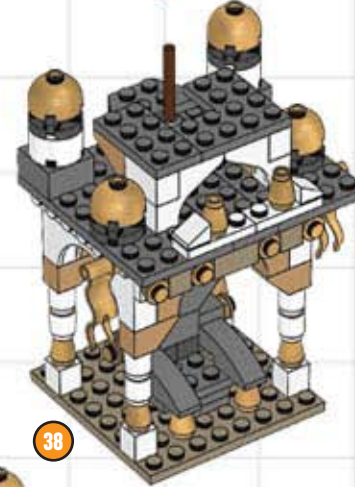
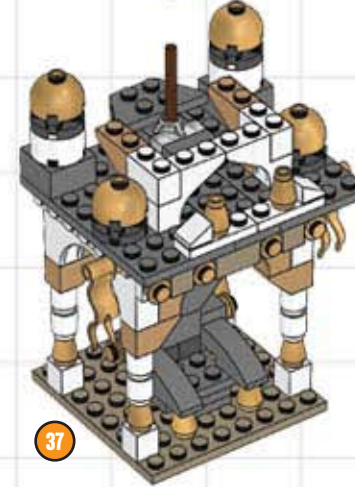
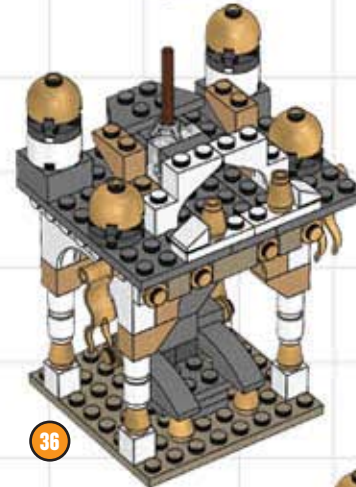
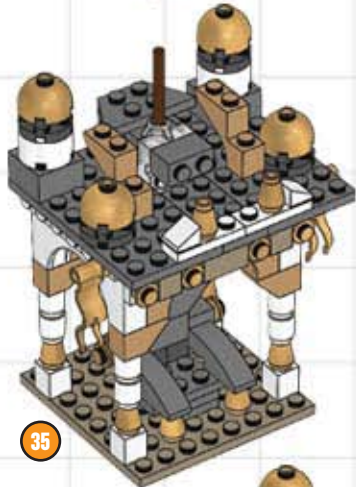
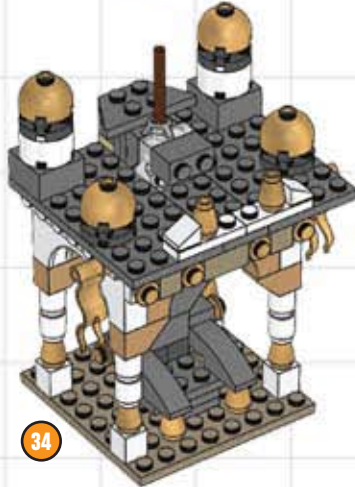
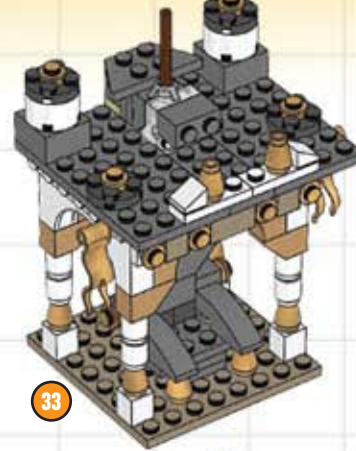
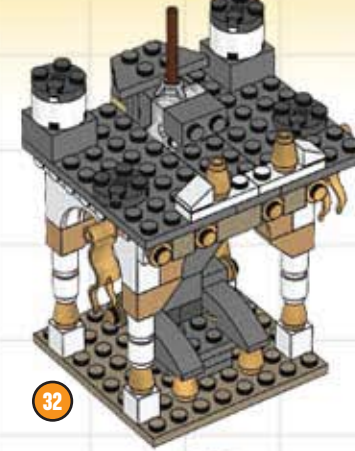
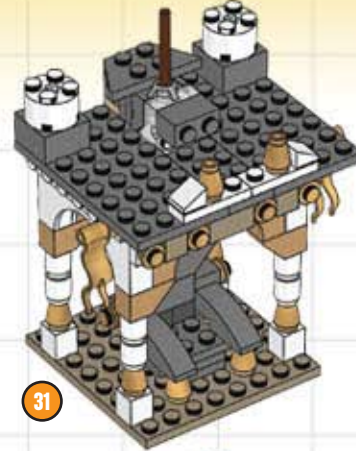
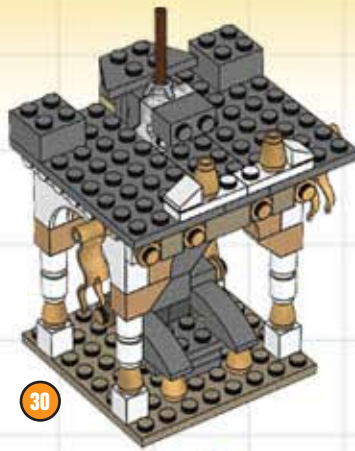
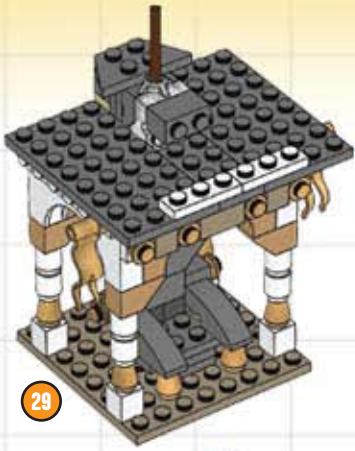

LEGO® PRINCE OF PERSIA BUILDING STEPS!

