

in the back of the car
with the engine

the car is very
fast and it is
very nice

the car is very
fast and it is
very nice

the car is very
fast and it is
very nice

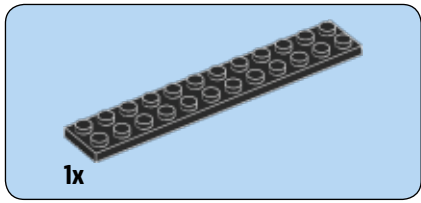

1

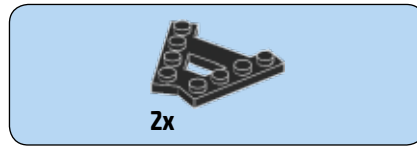
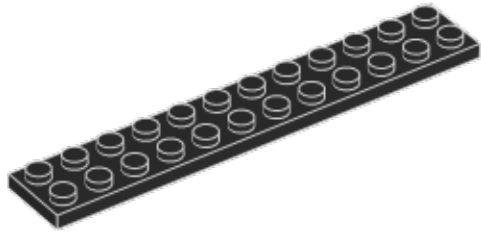

2

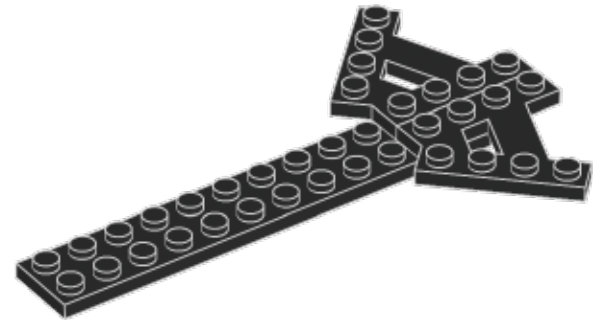



2x

3

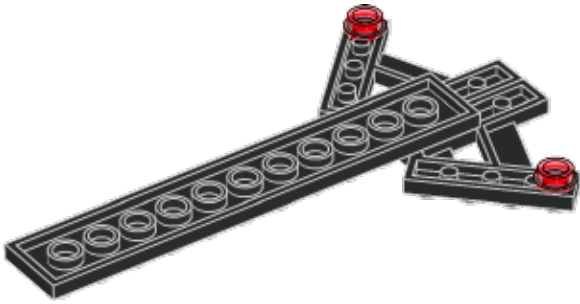

2x

4

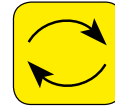



2x



2x

5

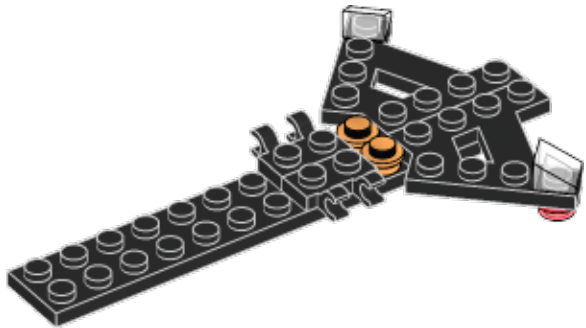

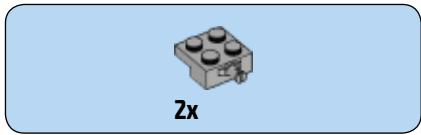

7

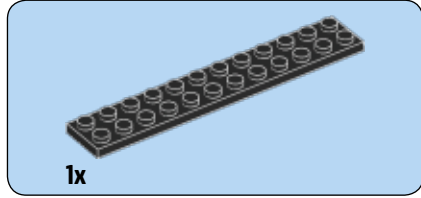
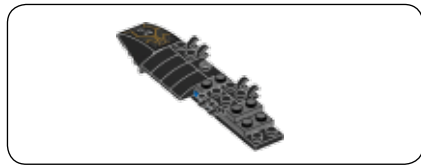
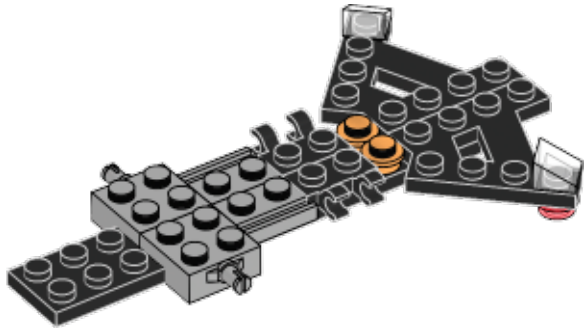

1

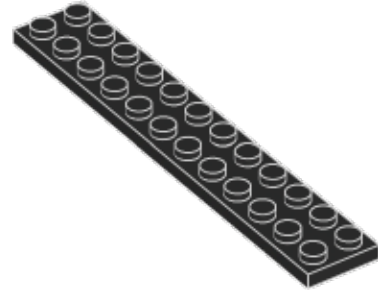

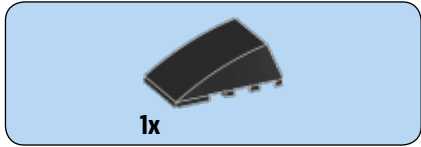
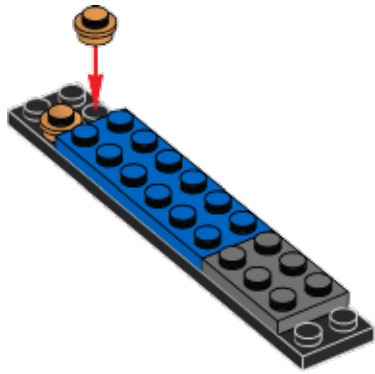

3

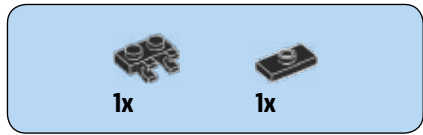
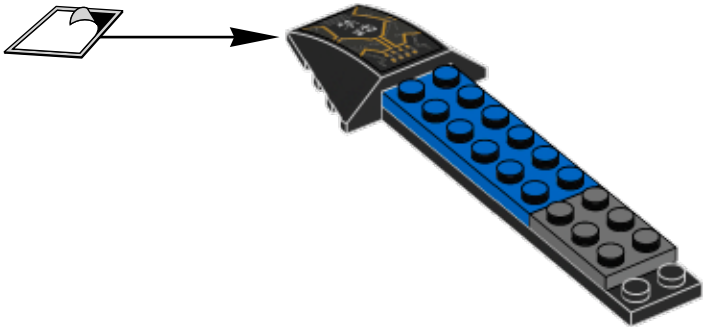

4

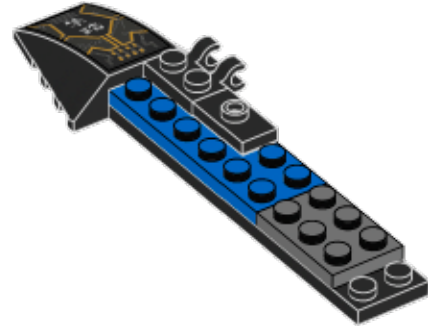

5

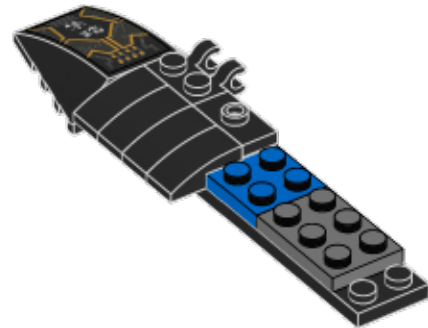

2x

2x

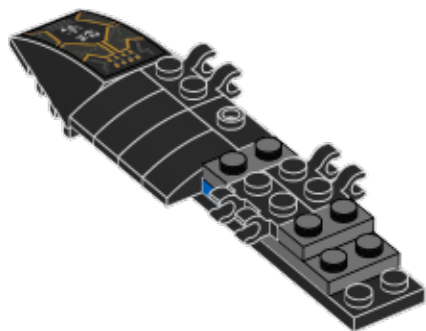

1x

7

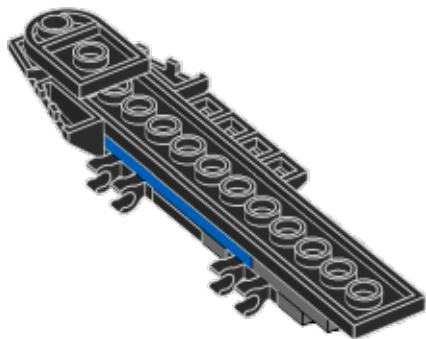
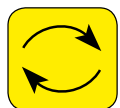

8

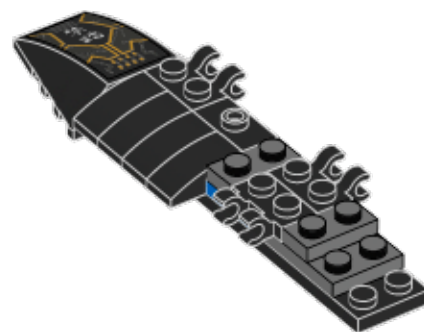

8

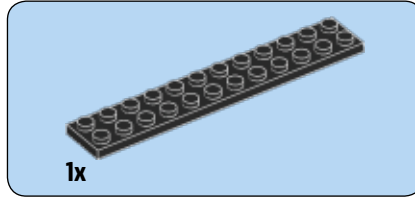
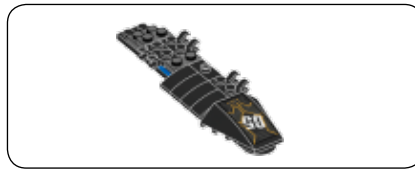
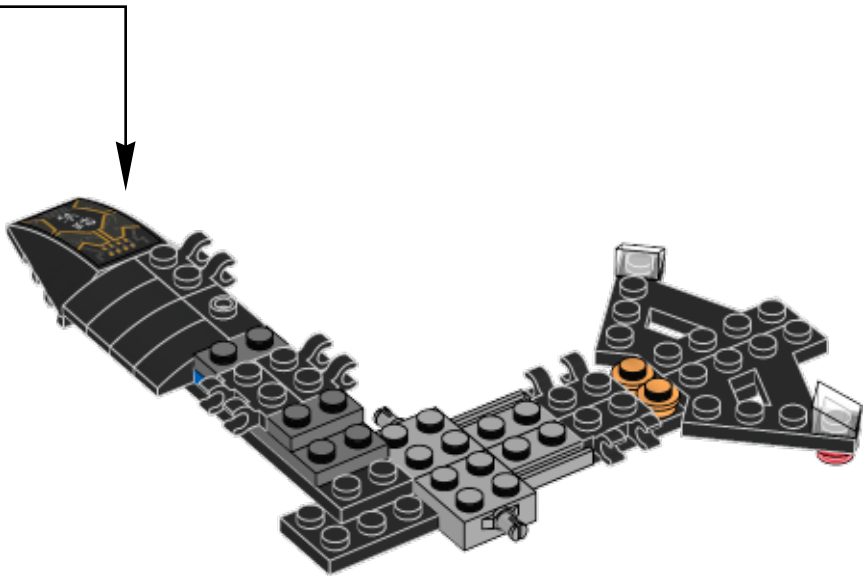

1

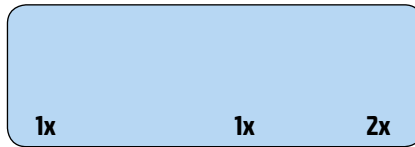
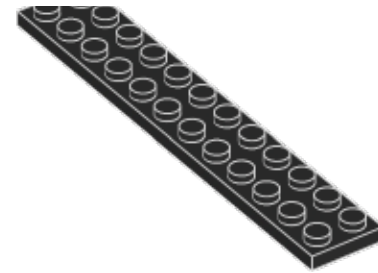

1x

2x

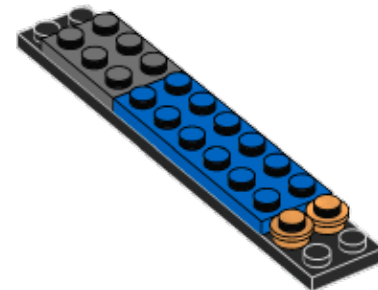

2x

2x

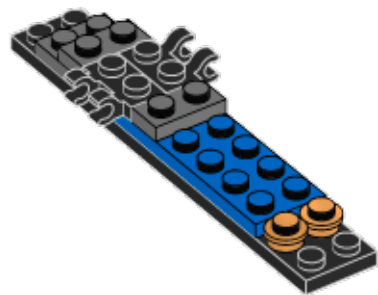

1x

1x

4

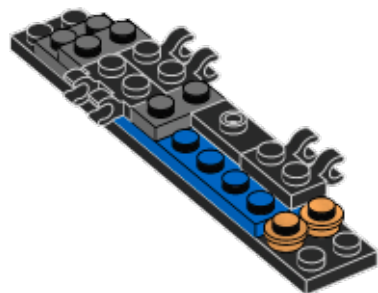

4x

5

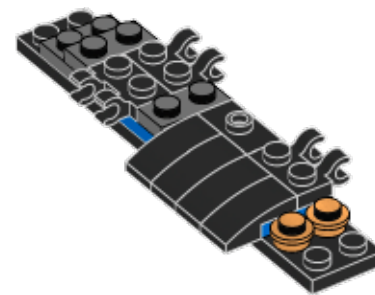

1x

6

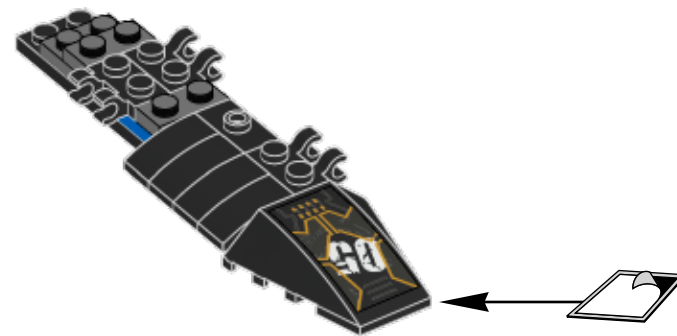

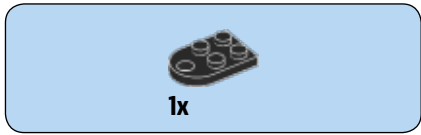

7

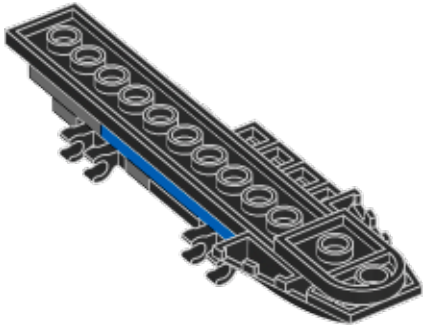

8

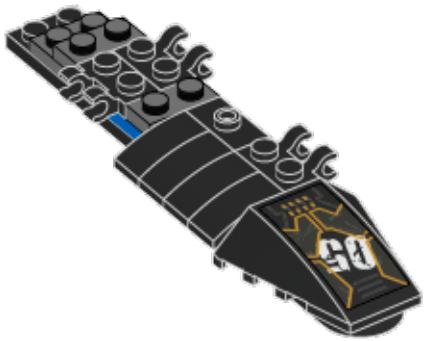
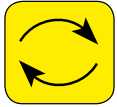

9

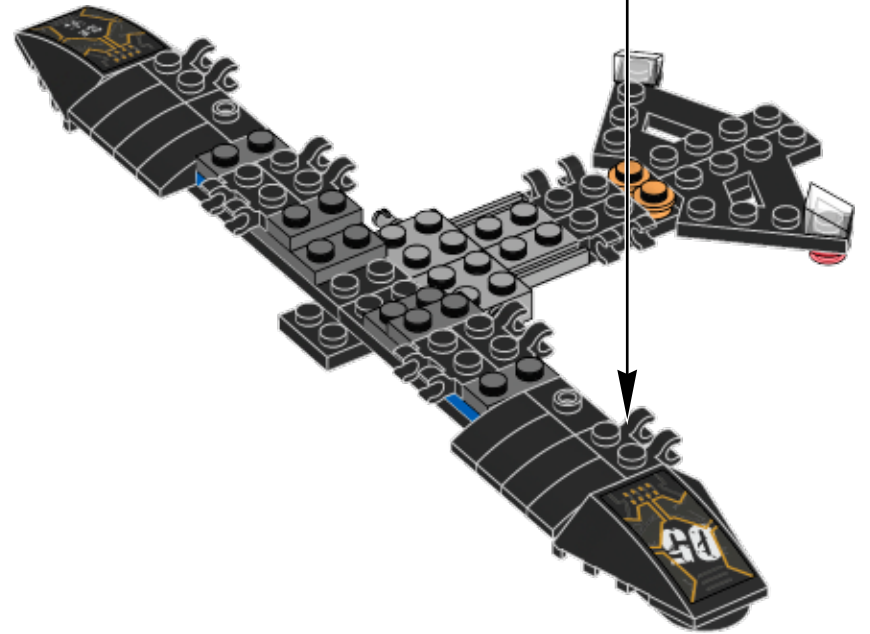



2x

10

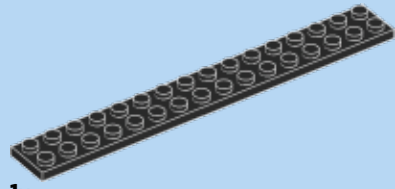
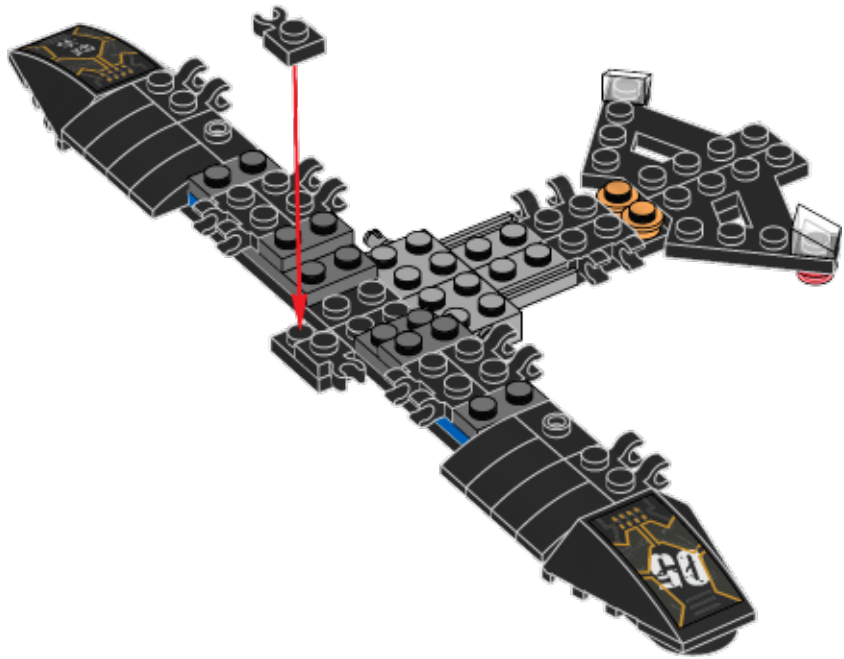

1x

11

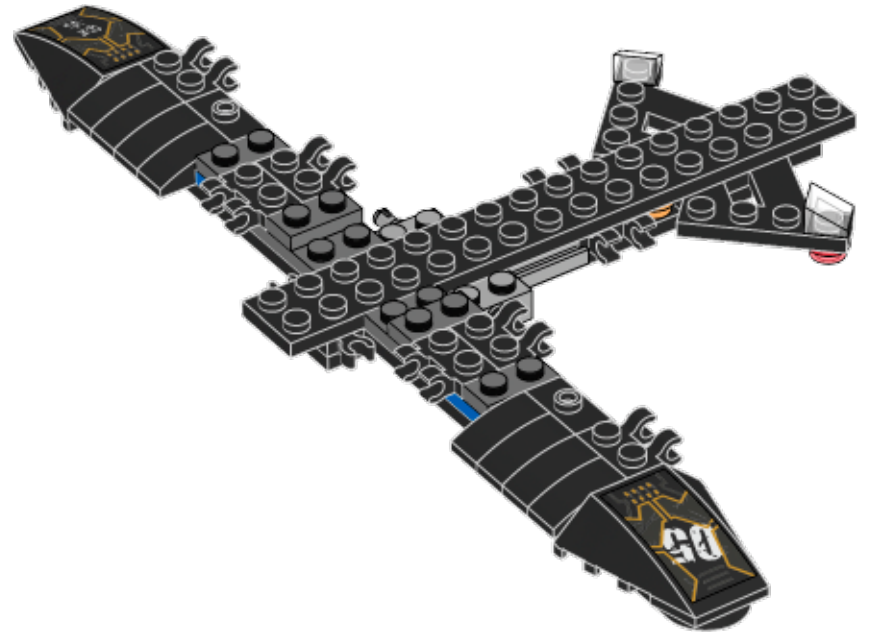

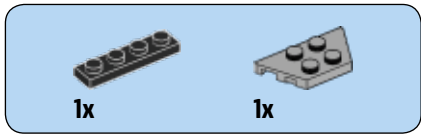

12

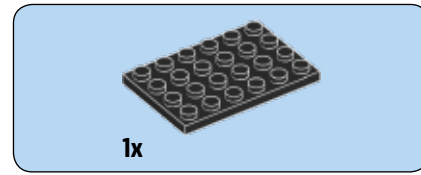
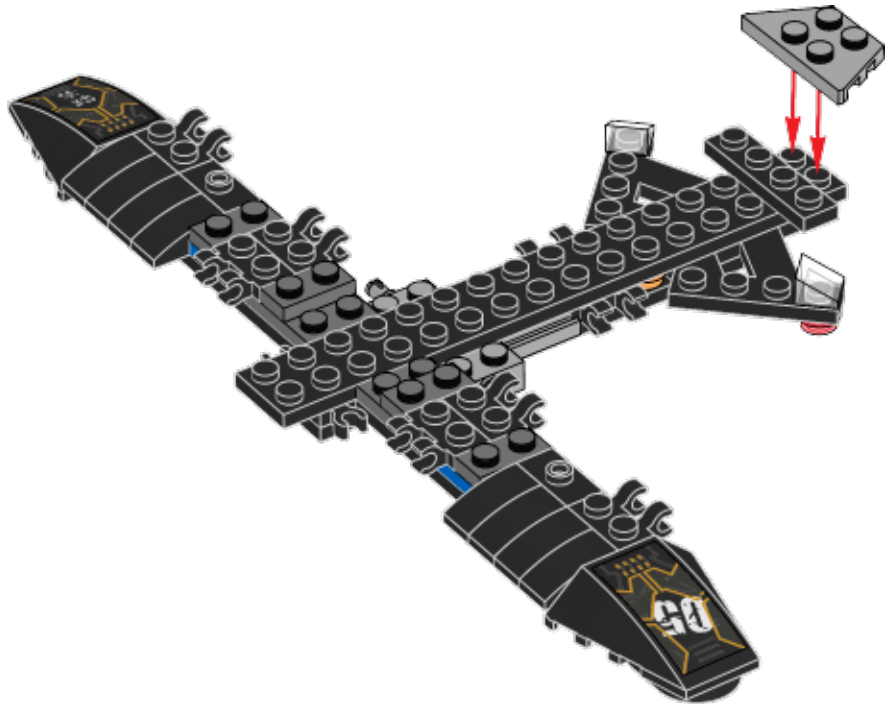

13

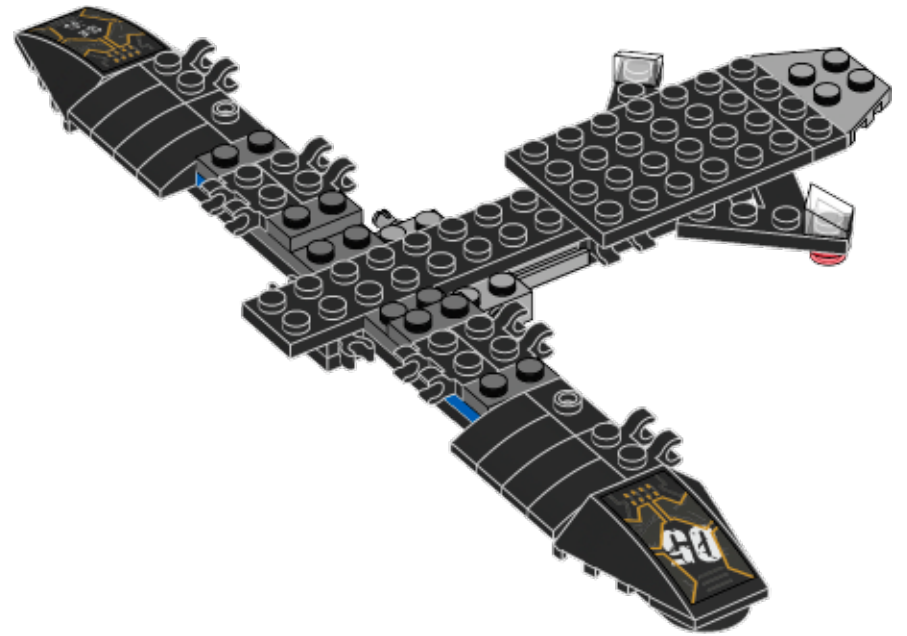

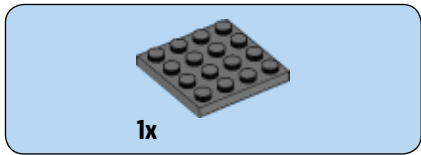

14

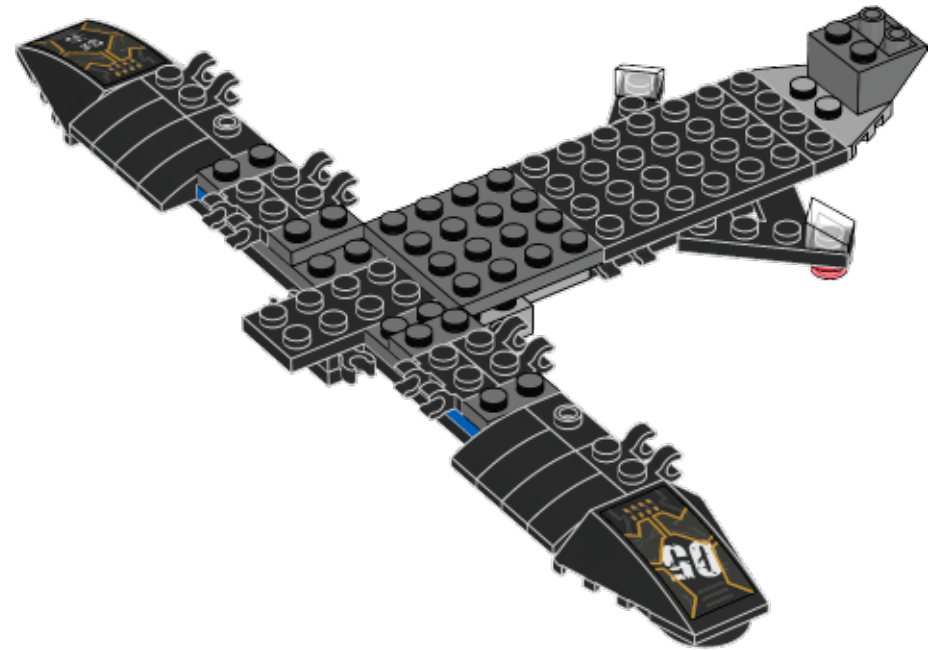
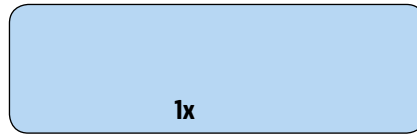
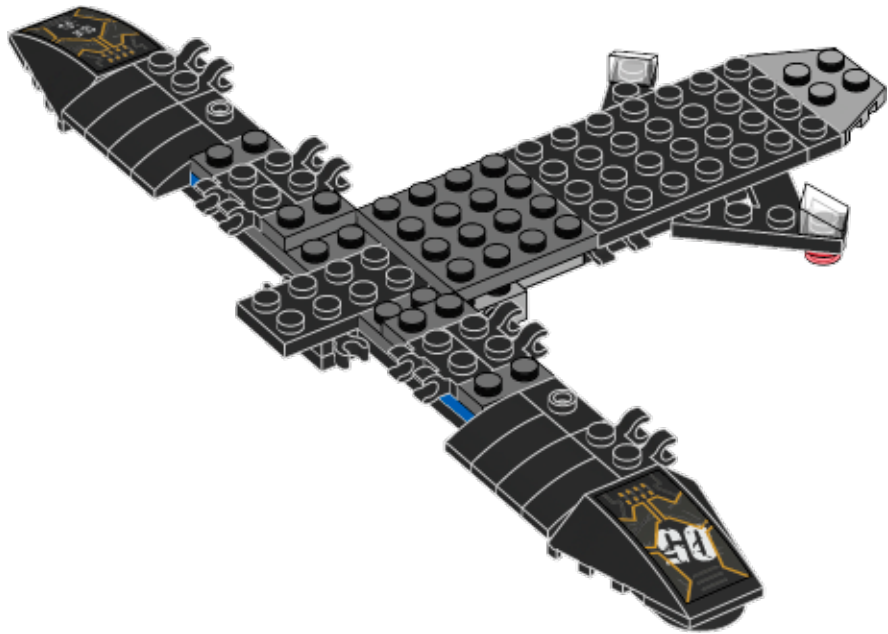



4x

17

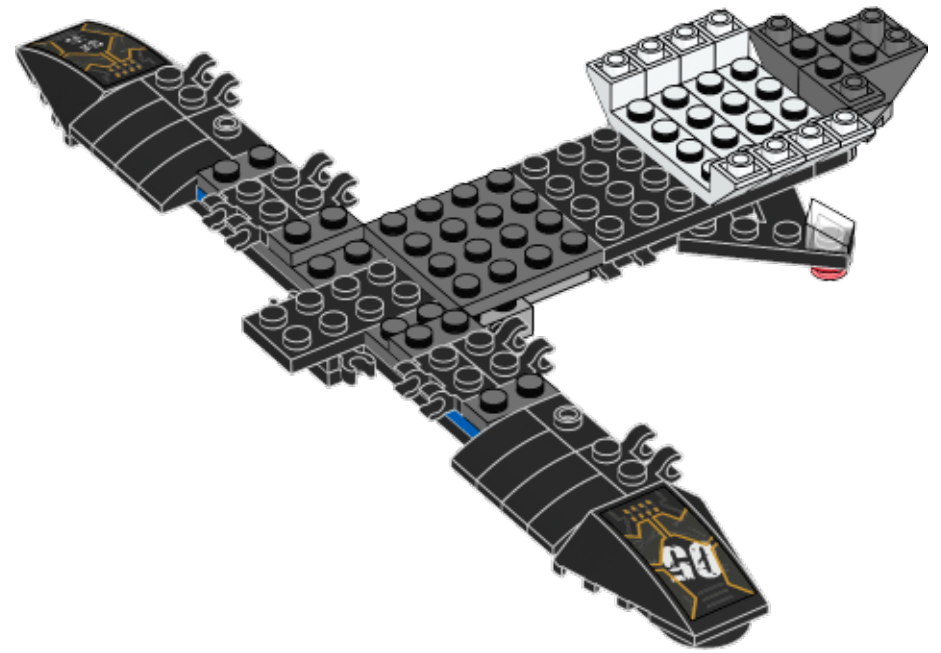
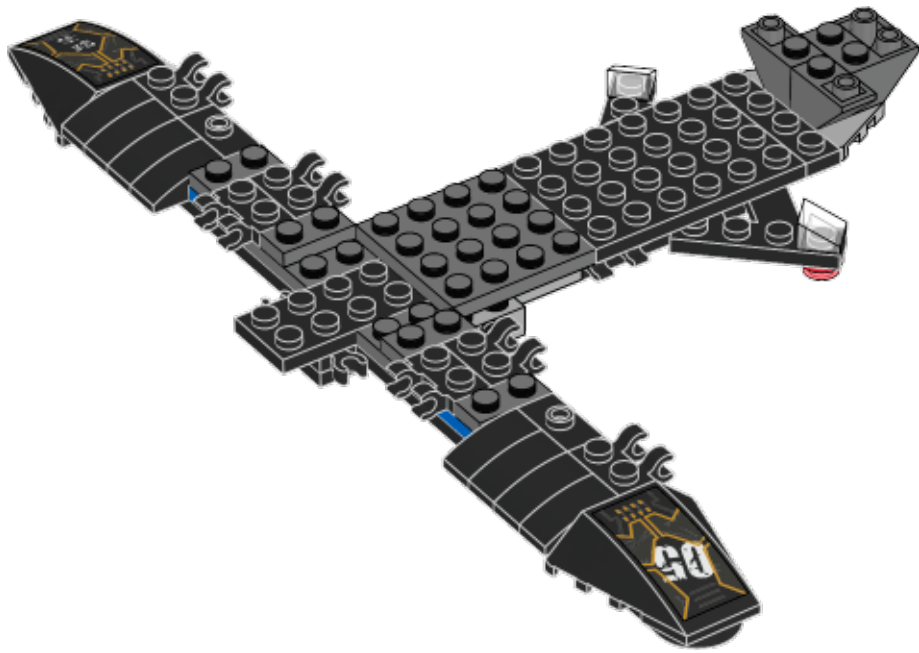

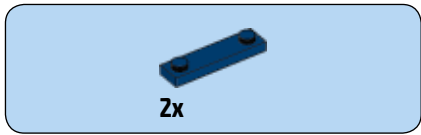

18

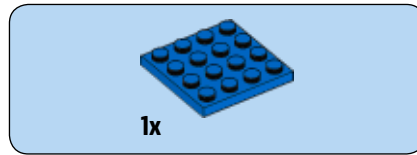
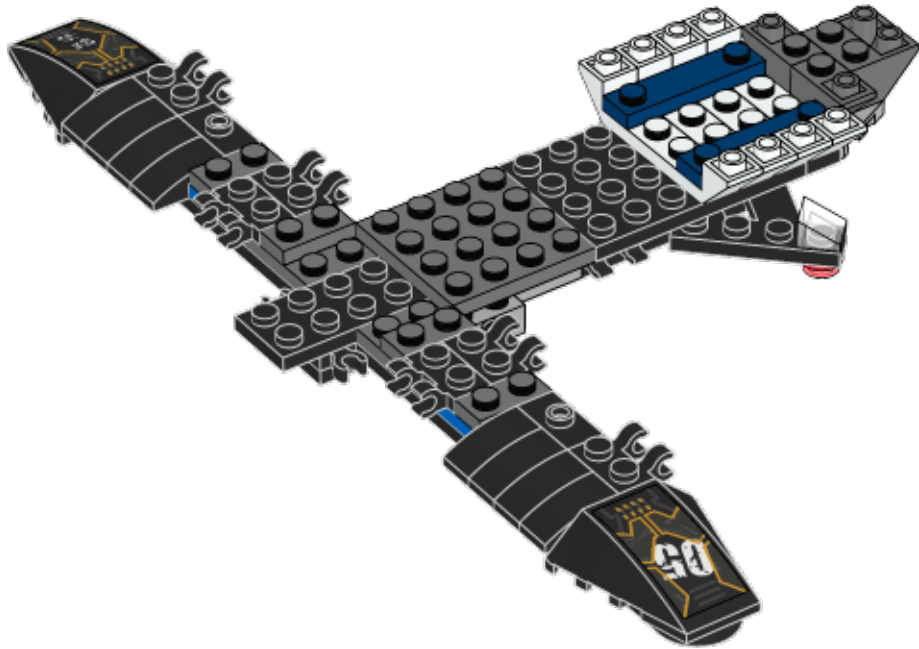

19

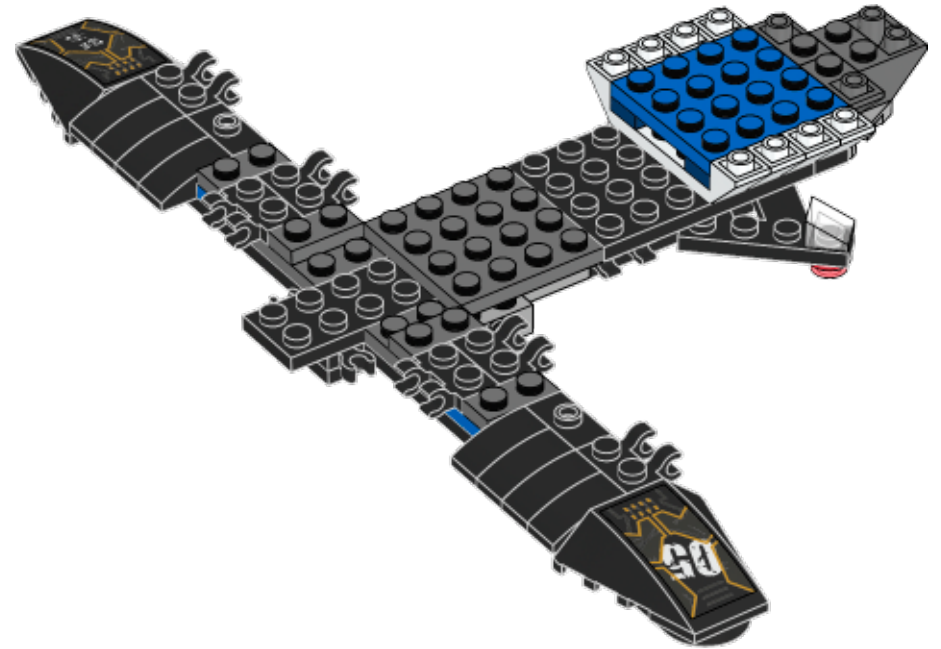

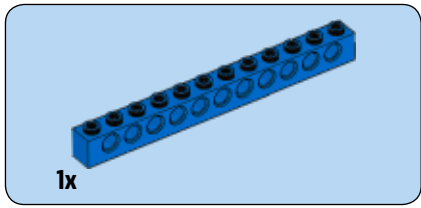

20

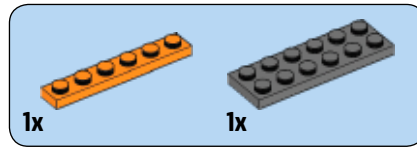
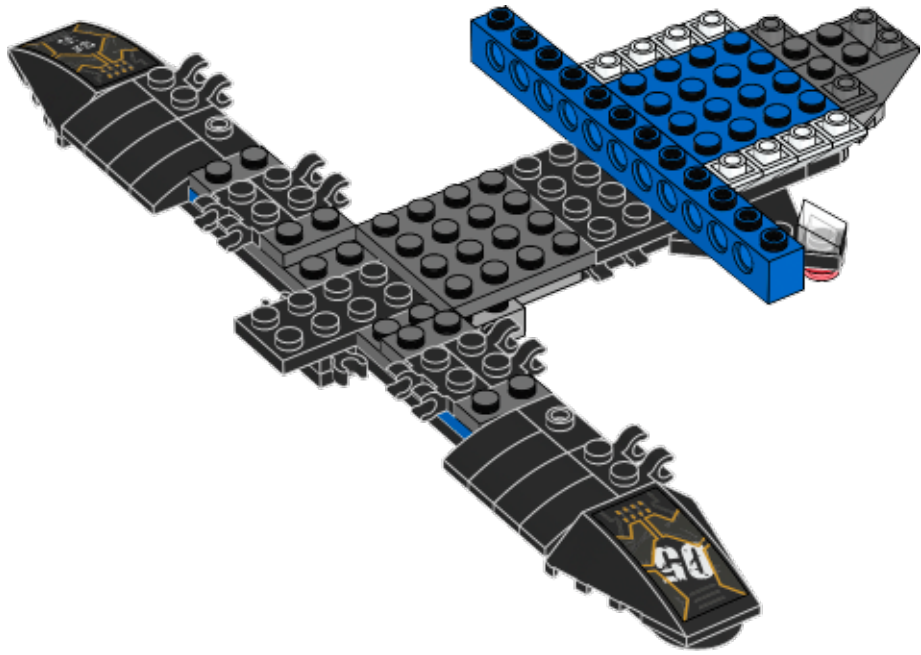

21

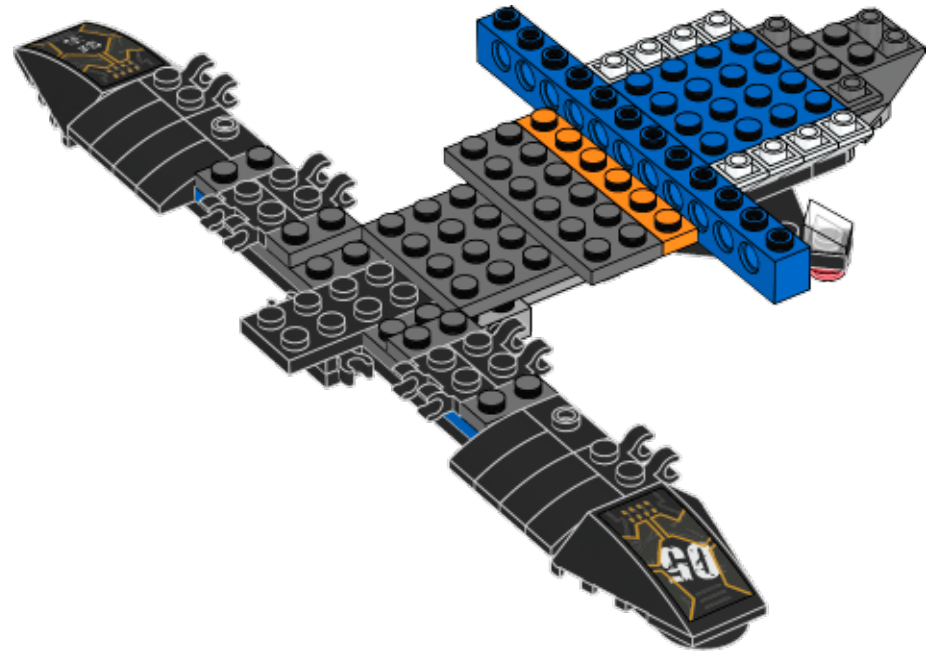



2x



4x

22

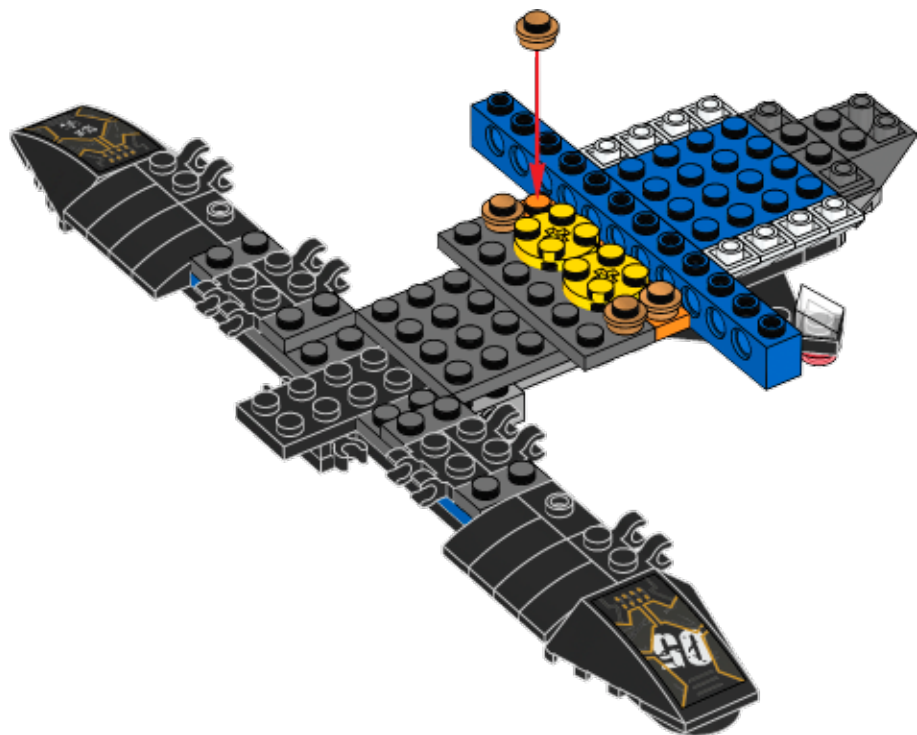

2x



1x

23

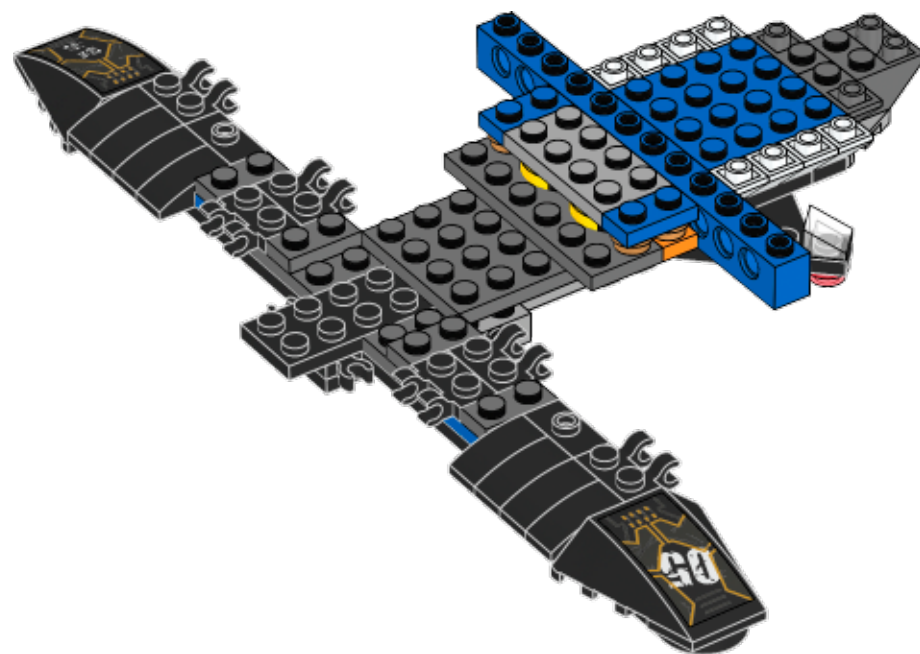



1x

24

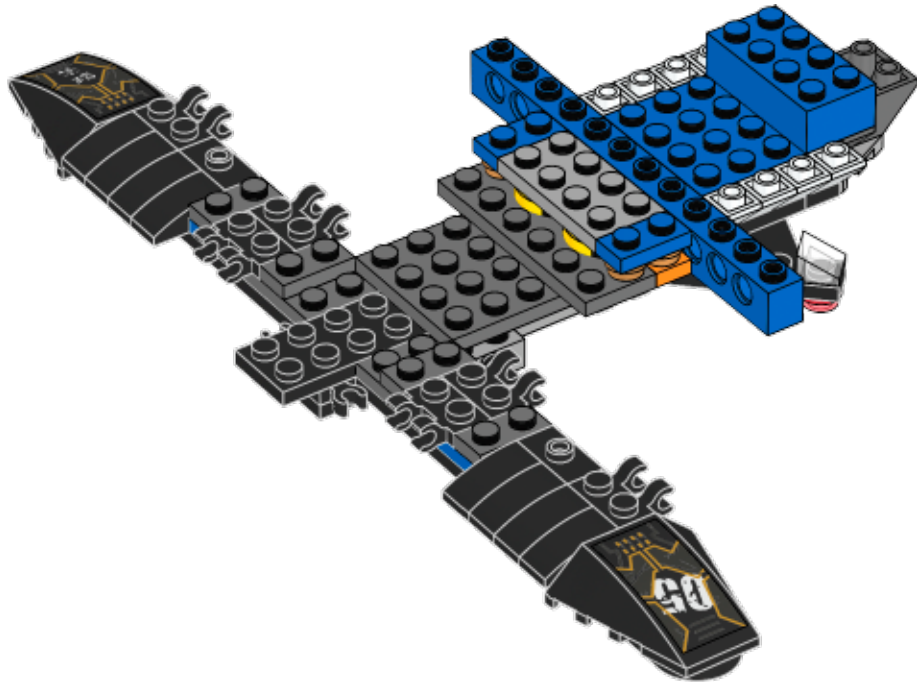

1x



1x

25

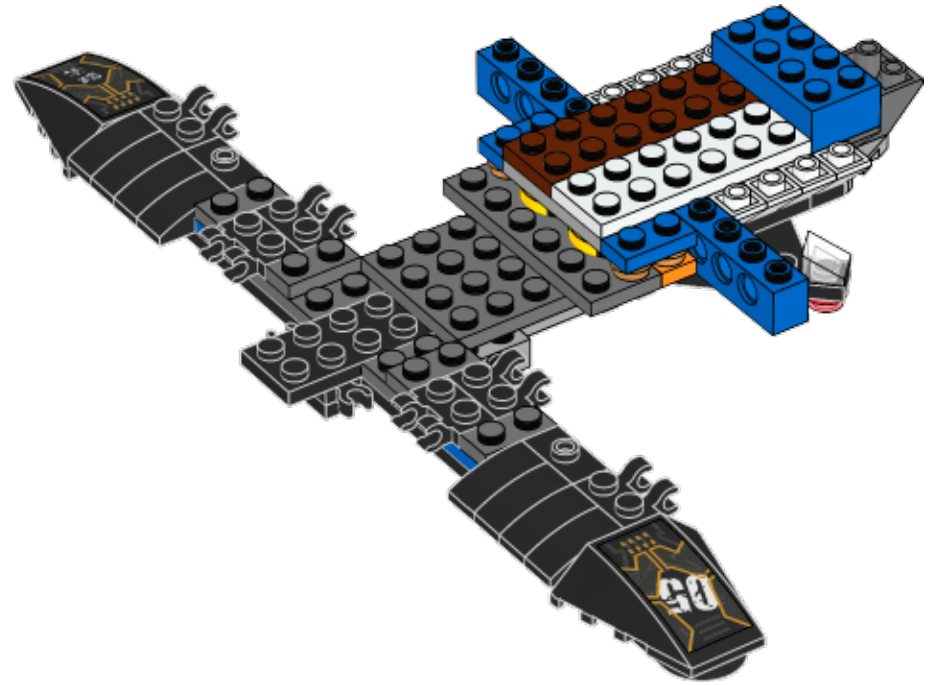

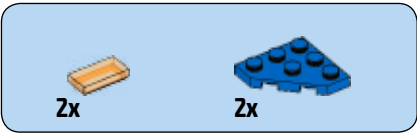

26

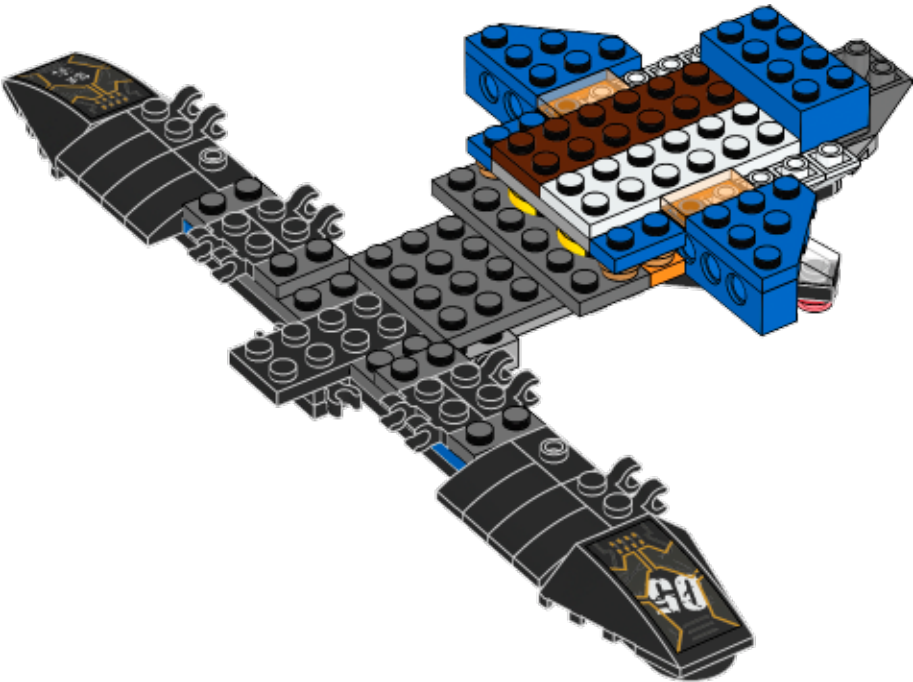

27

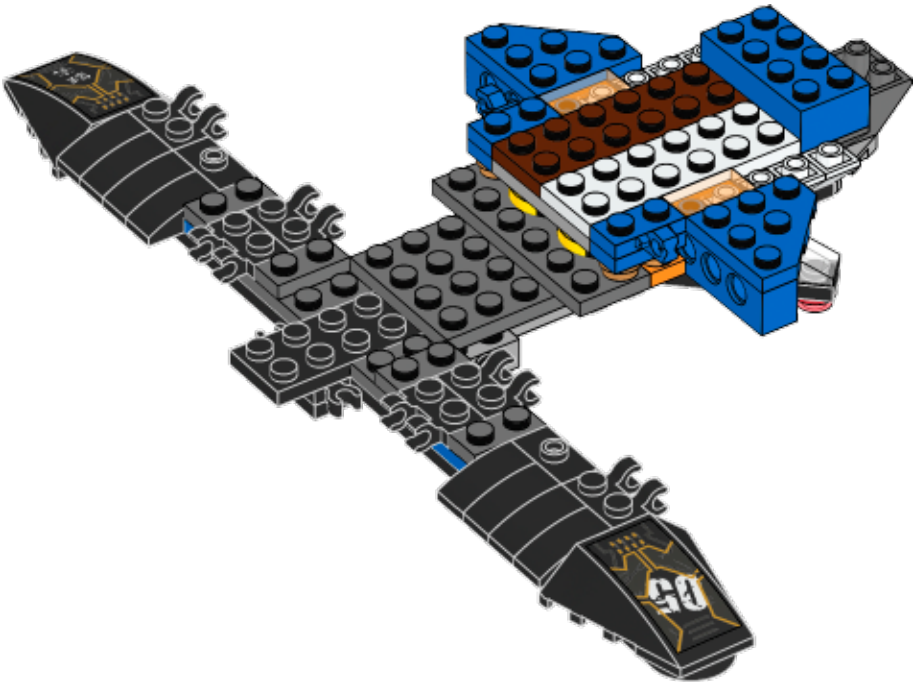



2x



2x

28

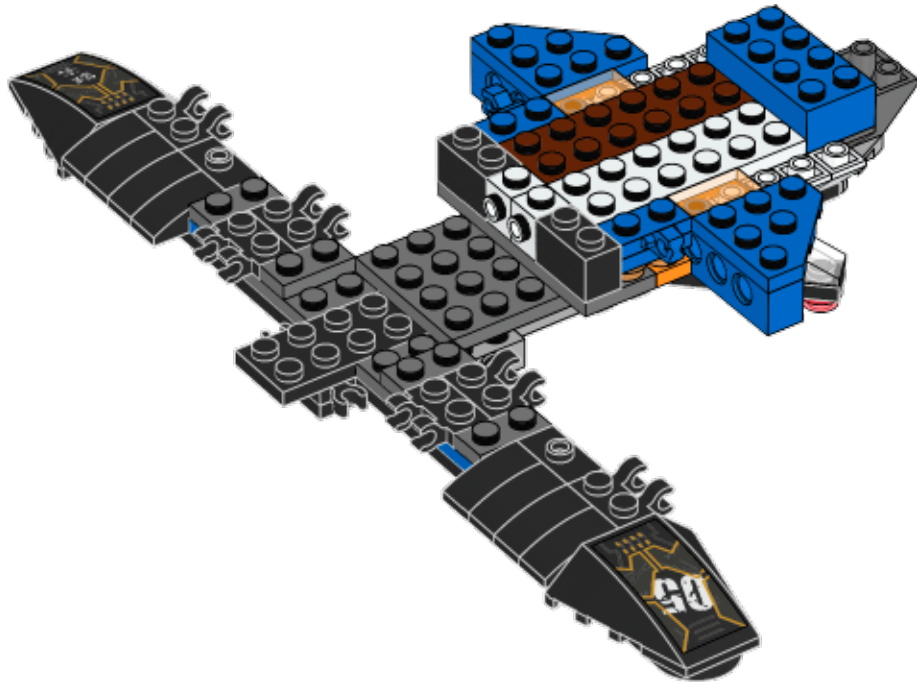

1x

29

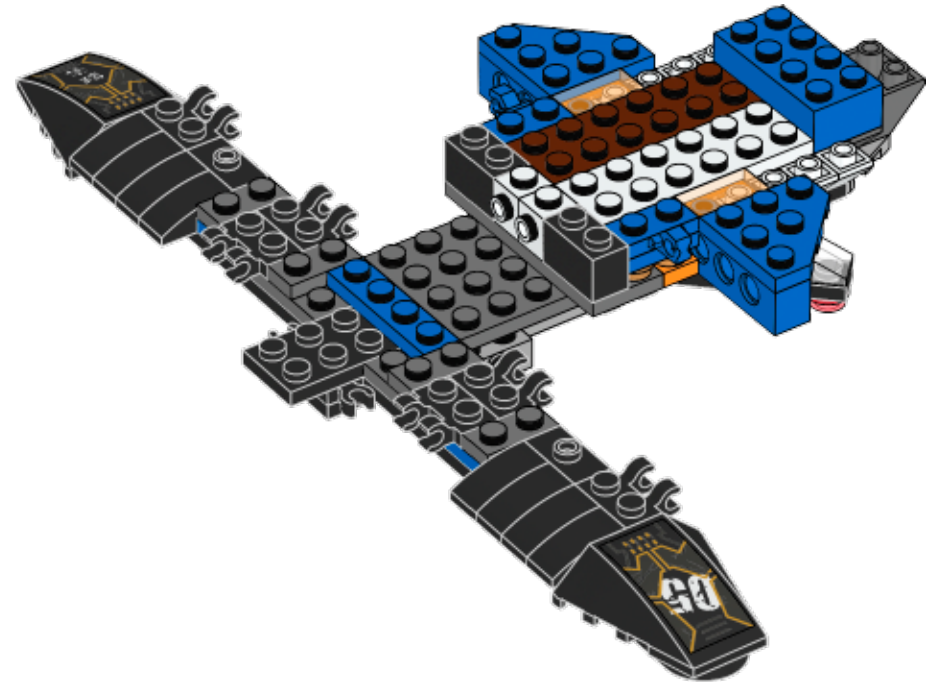



2x

30

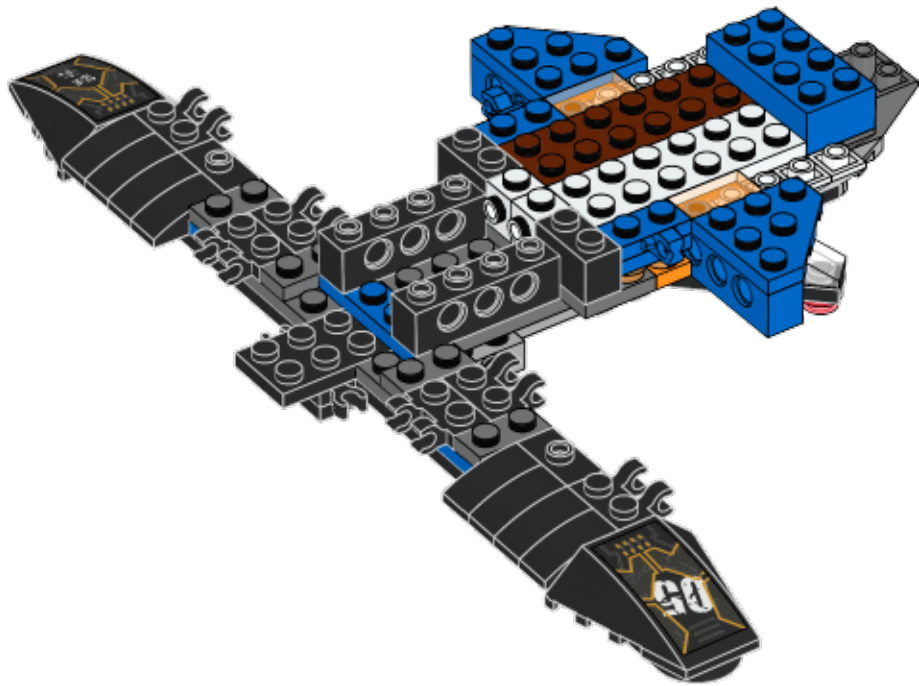

1x

31

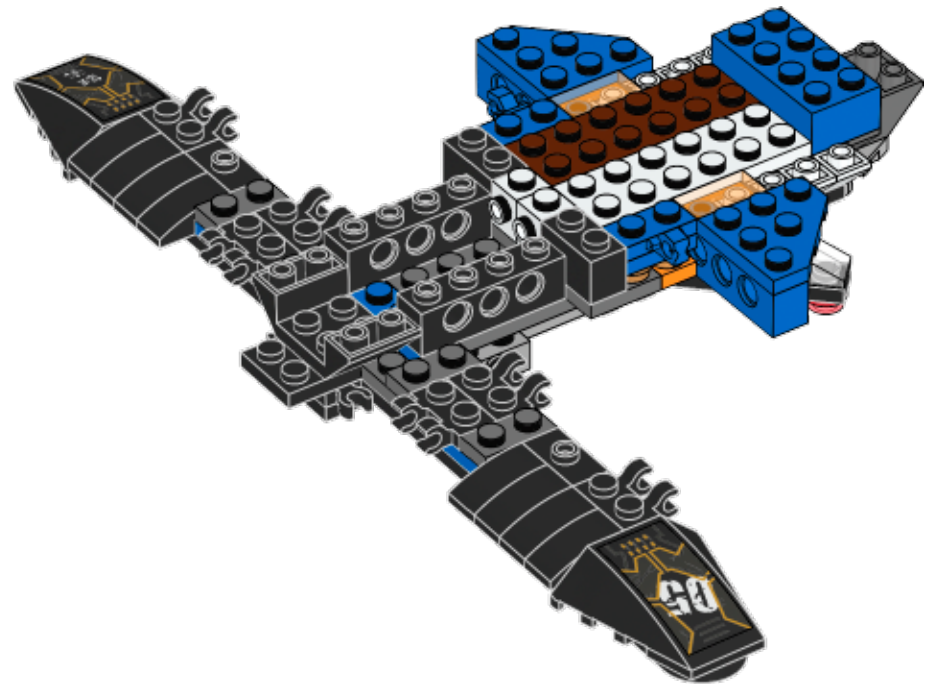



32

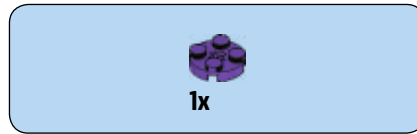
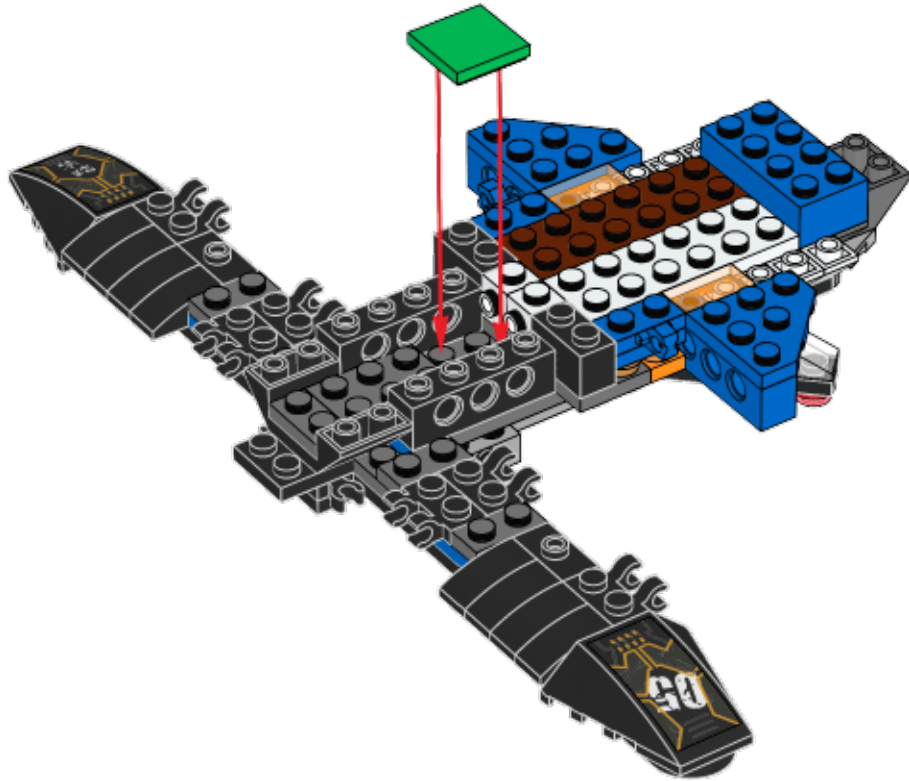

33

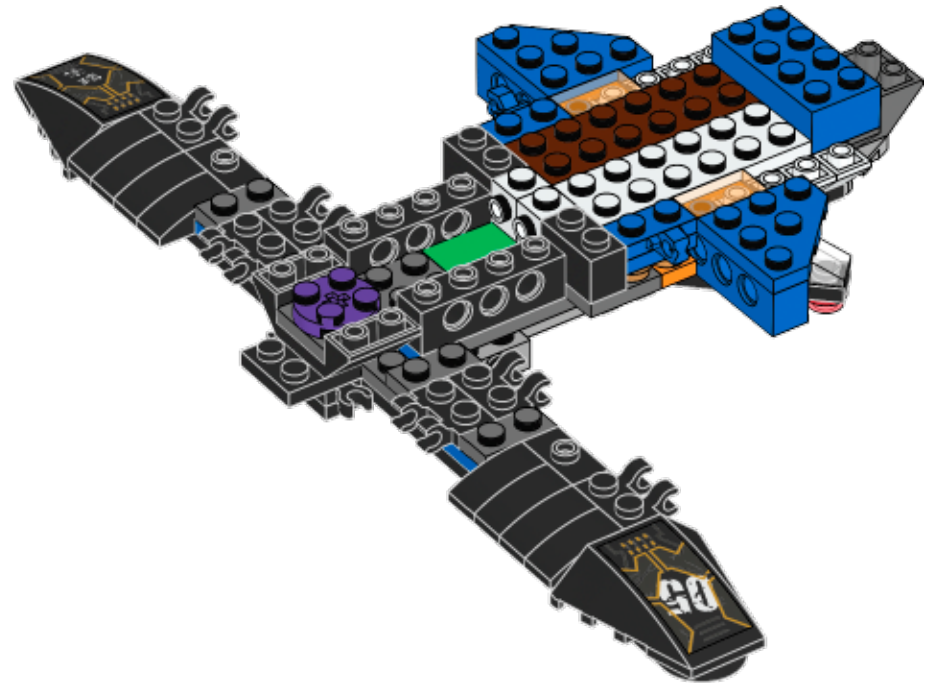



2x

34

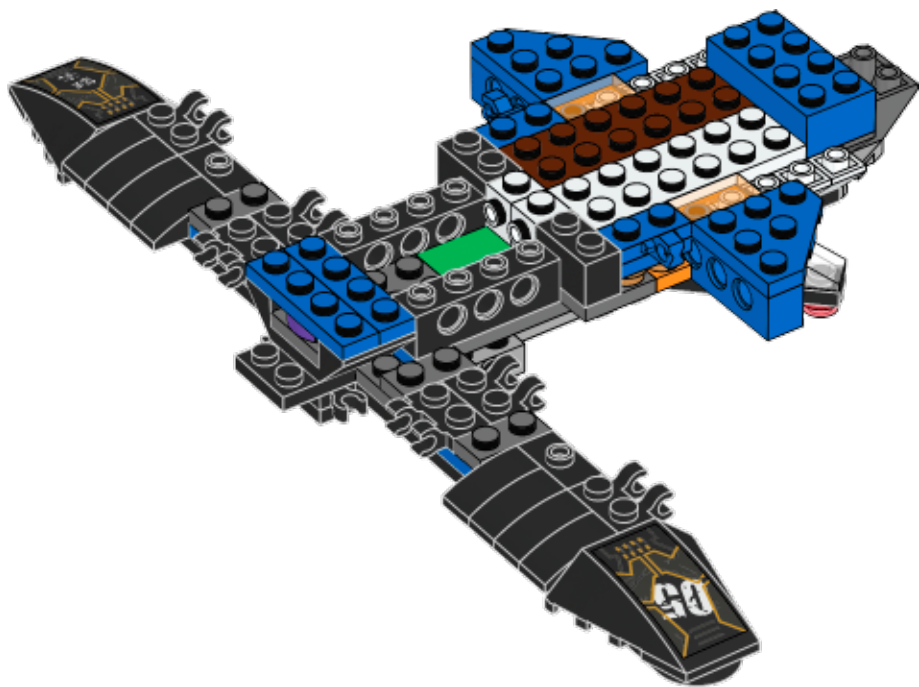

2x



2x

35

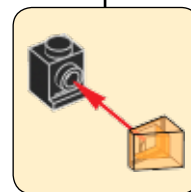
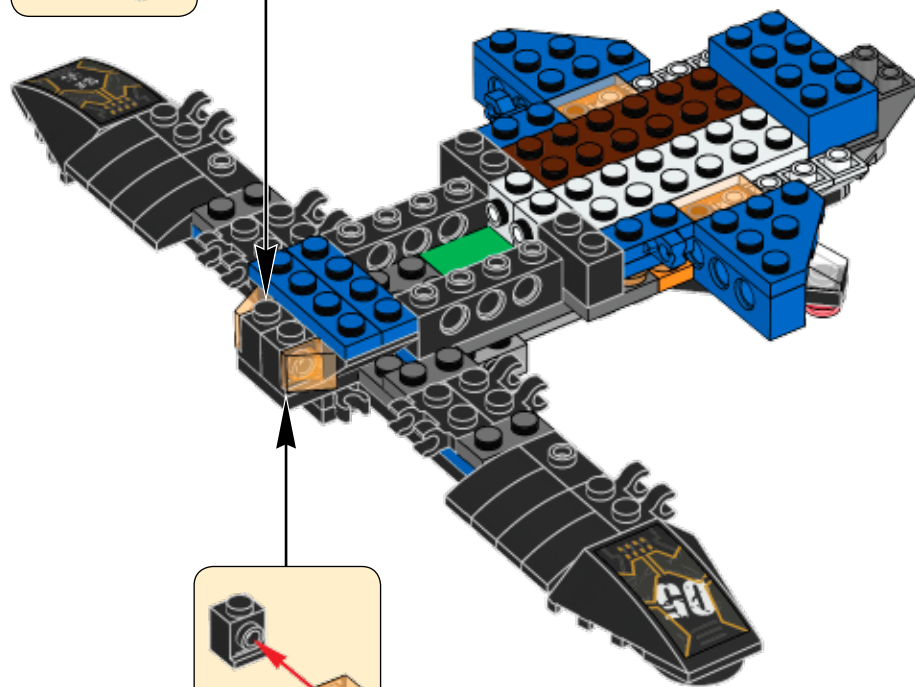
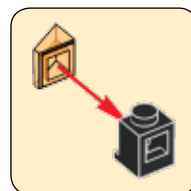

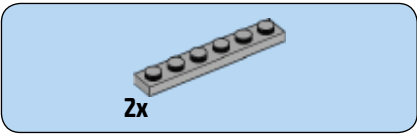

36

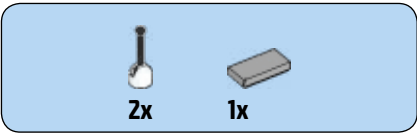
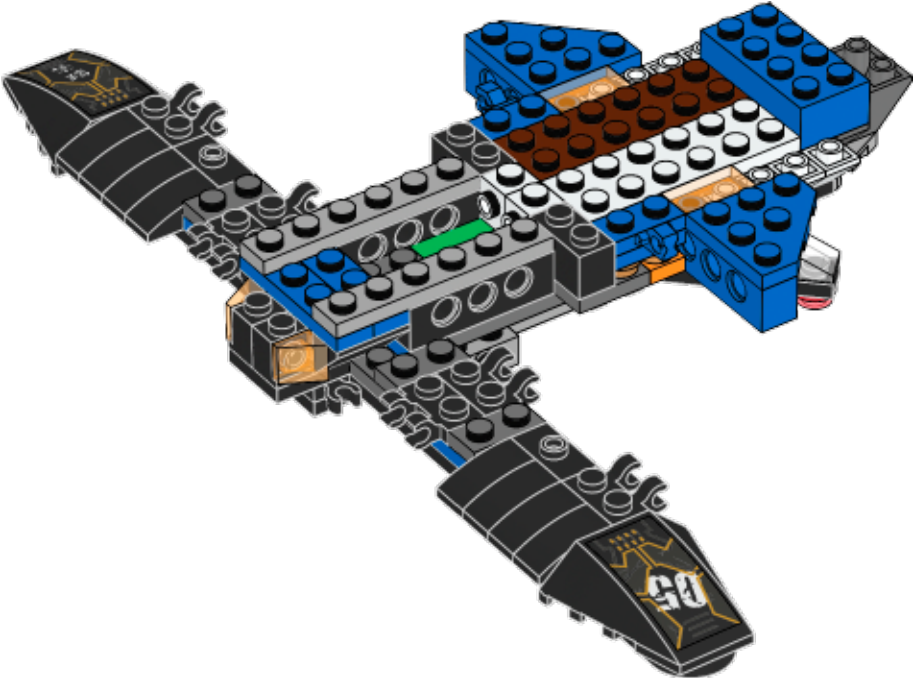

37

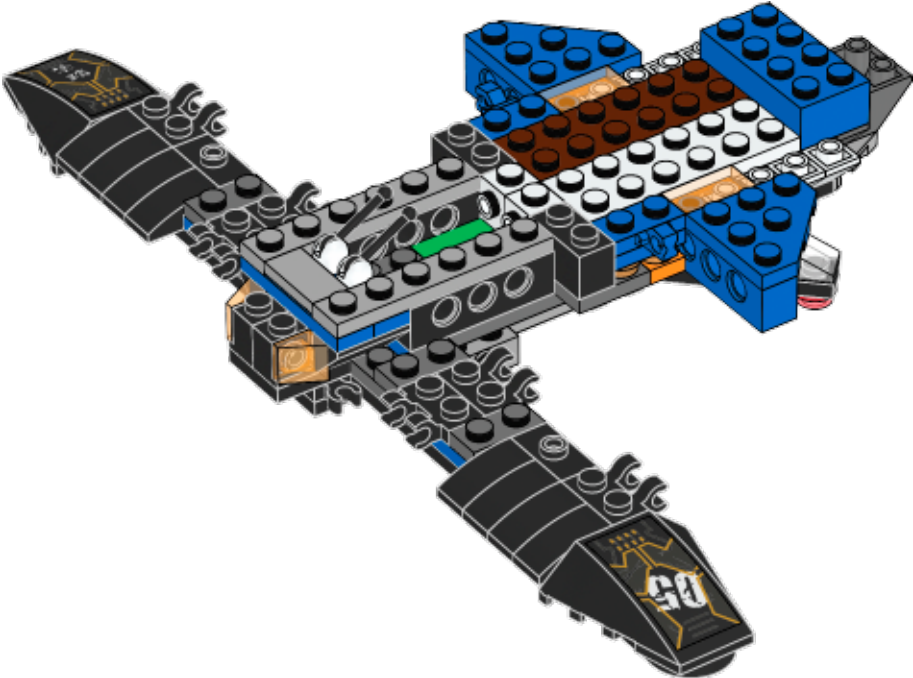

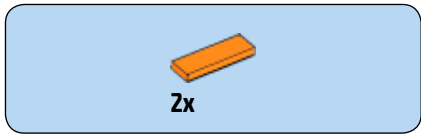

38

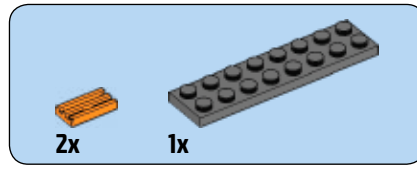
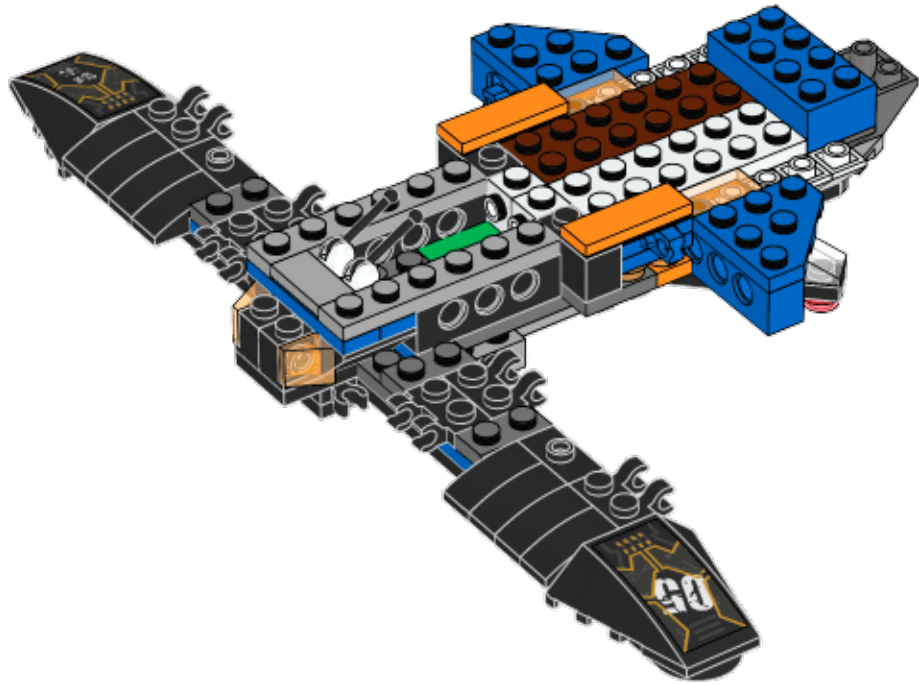

39

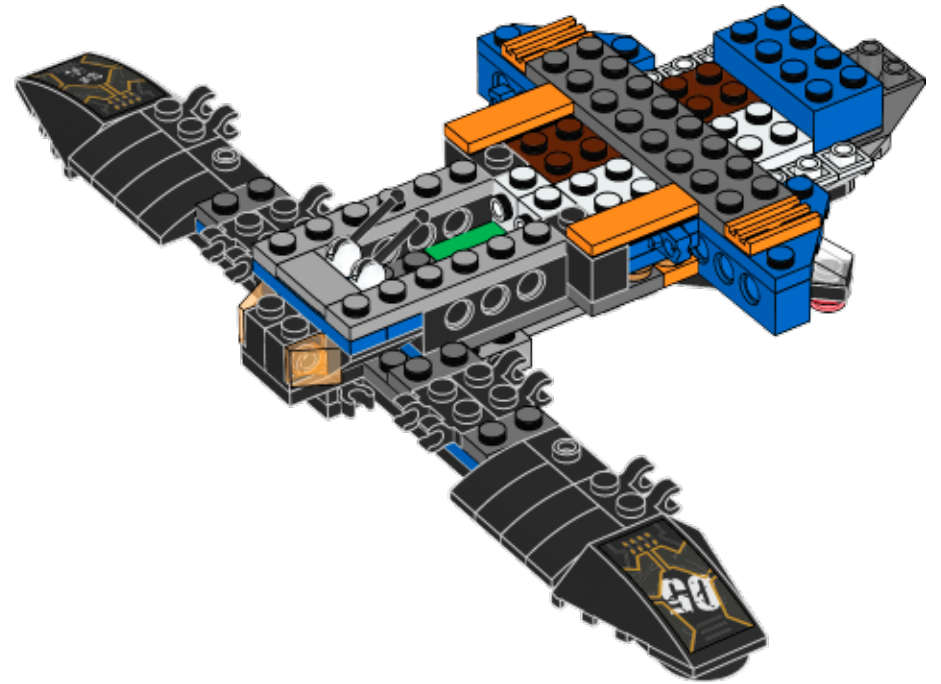



40

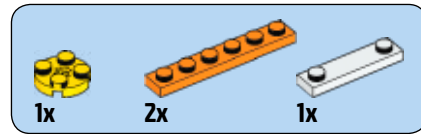
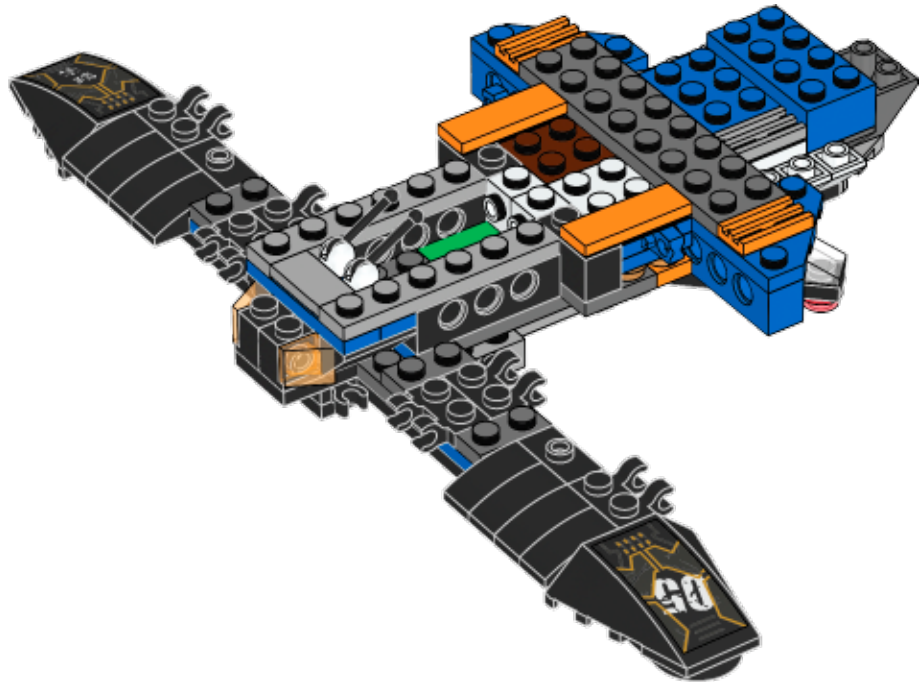

41

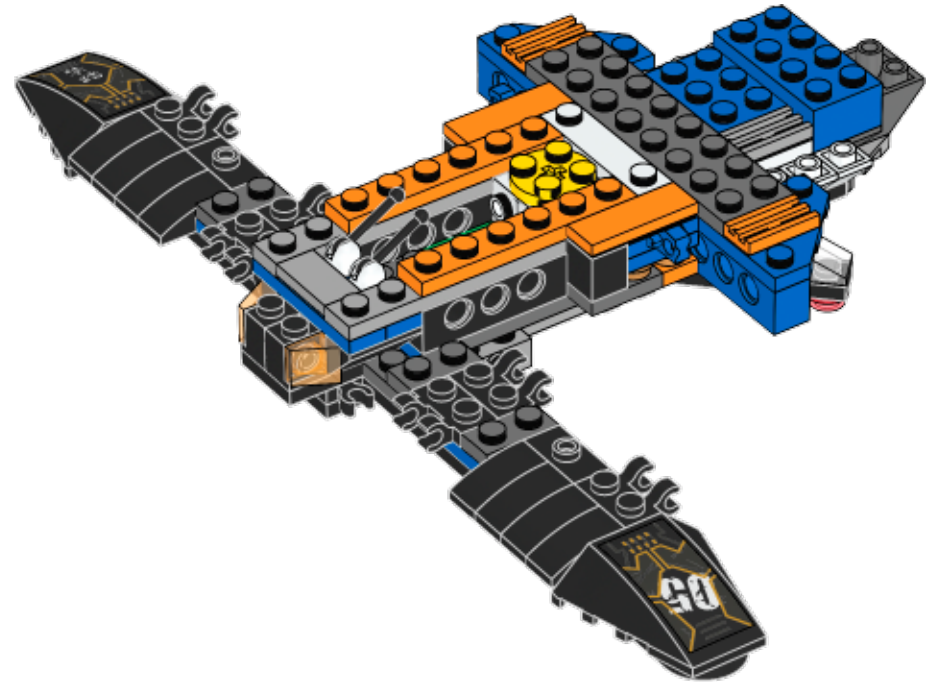



2x



2x

42

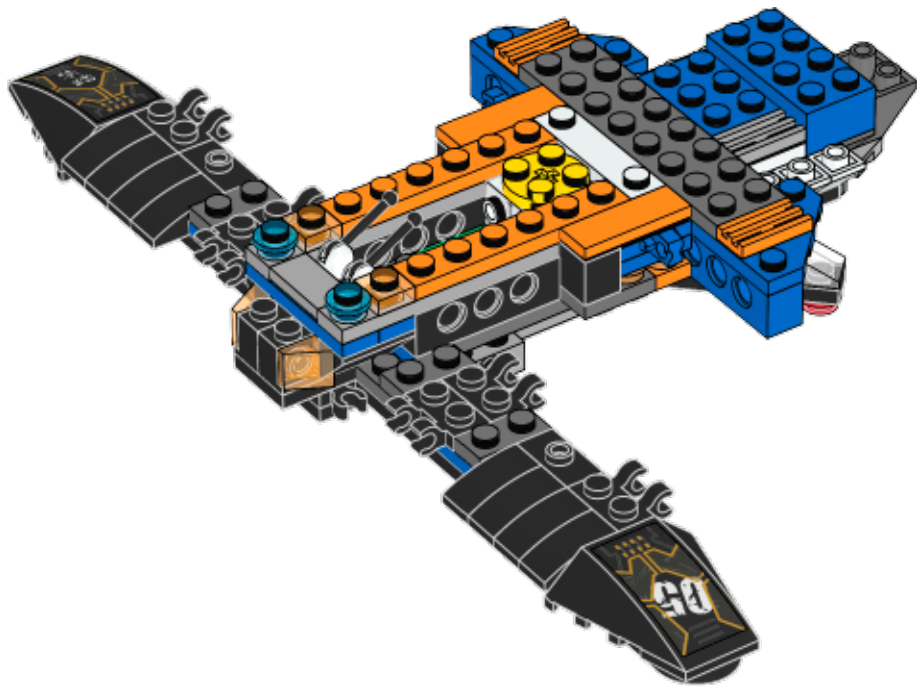

1x

43

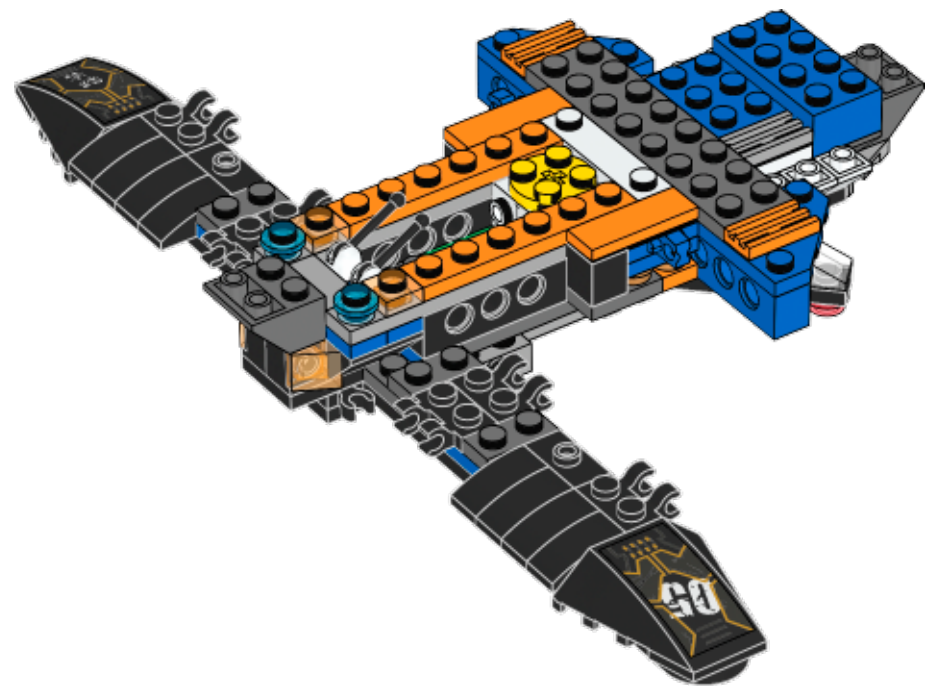

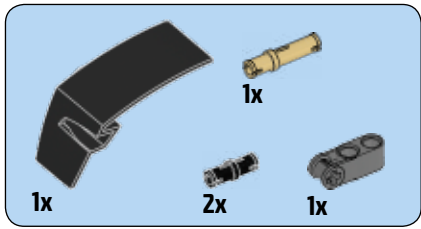

44

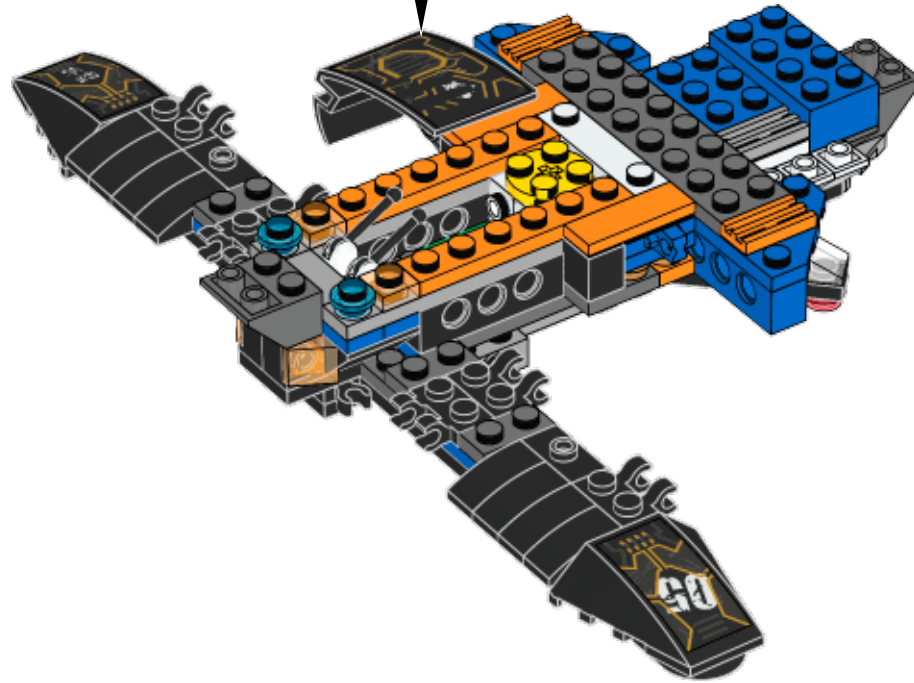
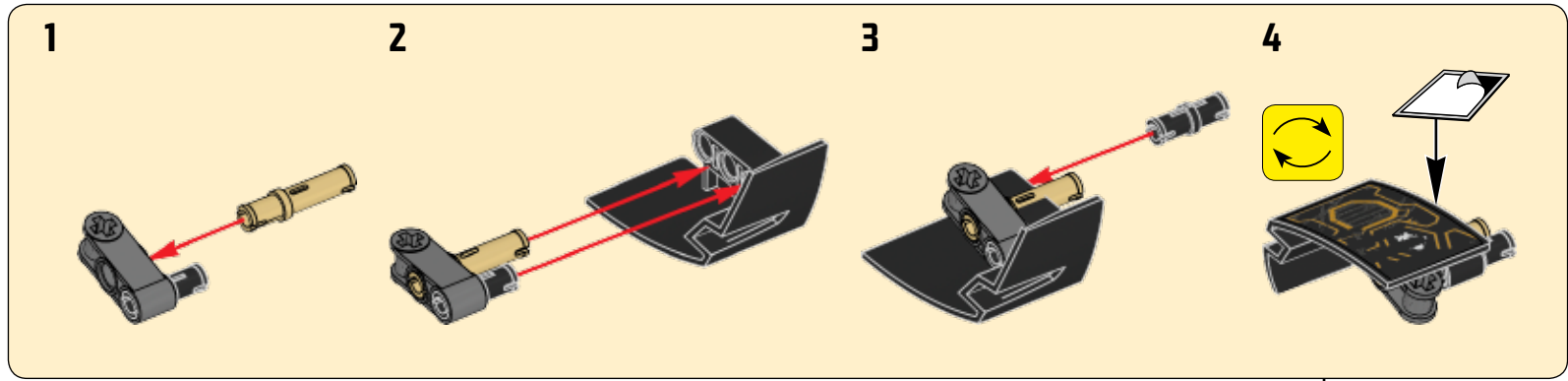

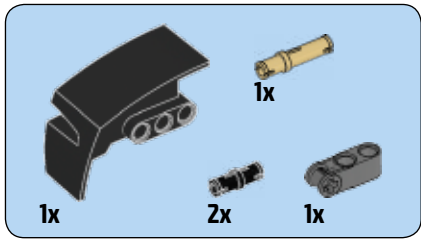

45

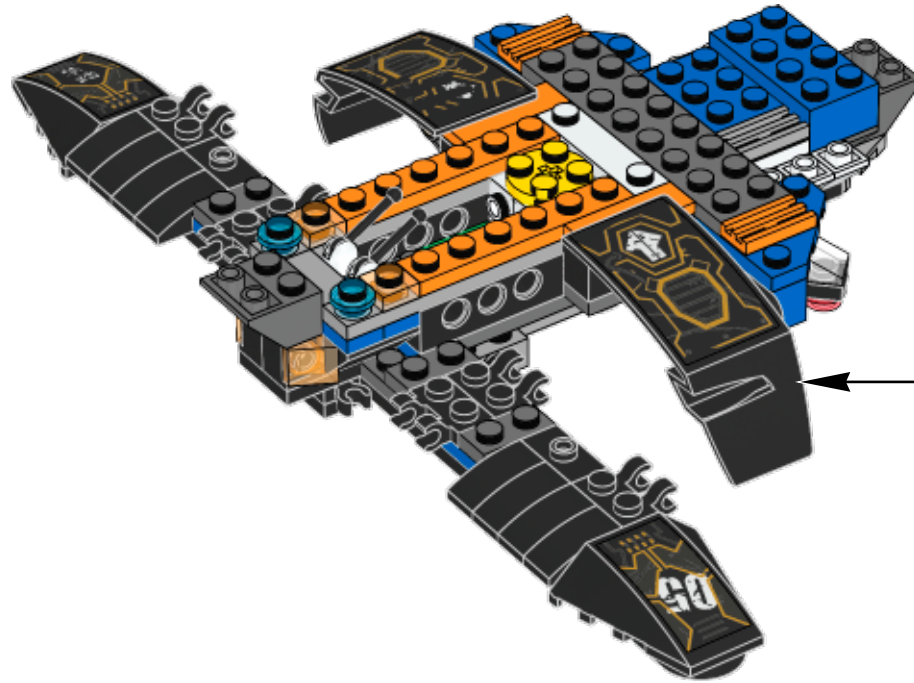
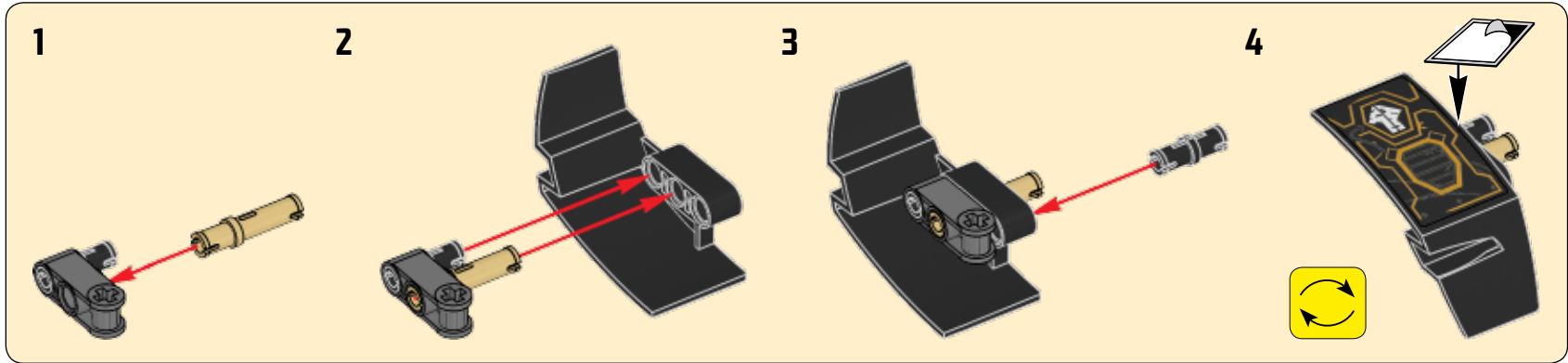

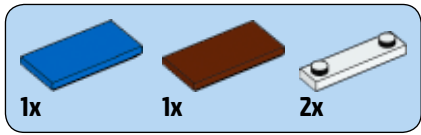

46

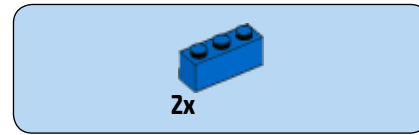
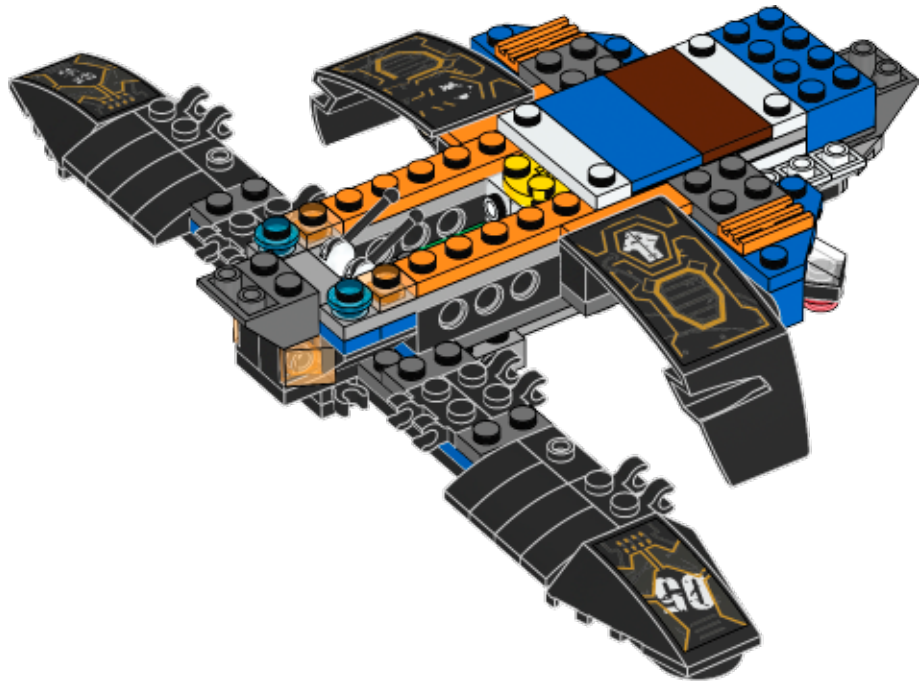

47

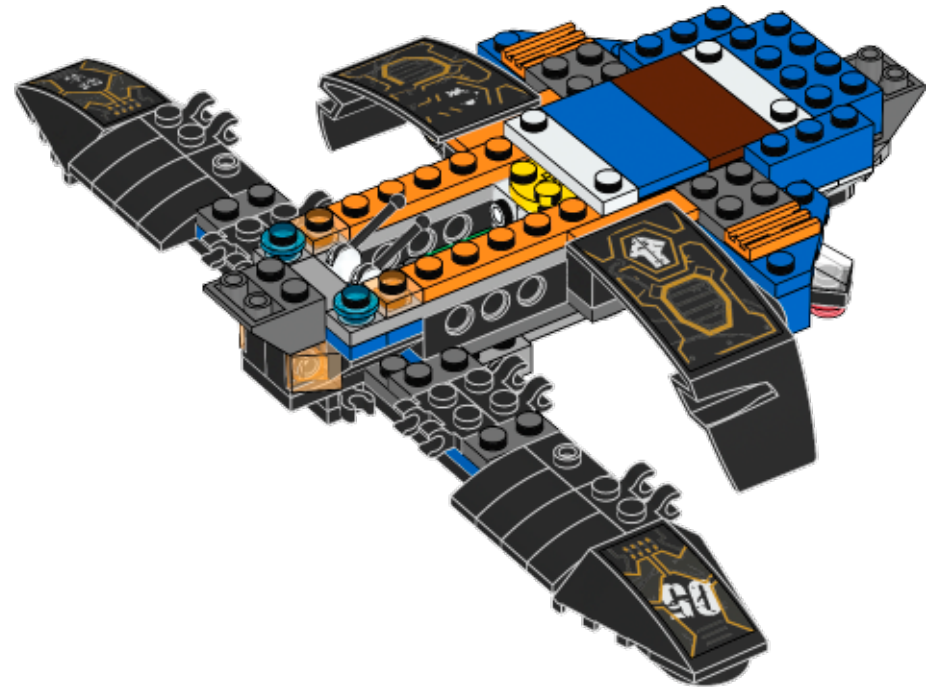



2x



2x

48

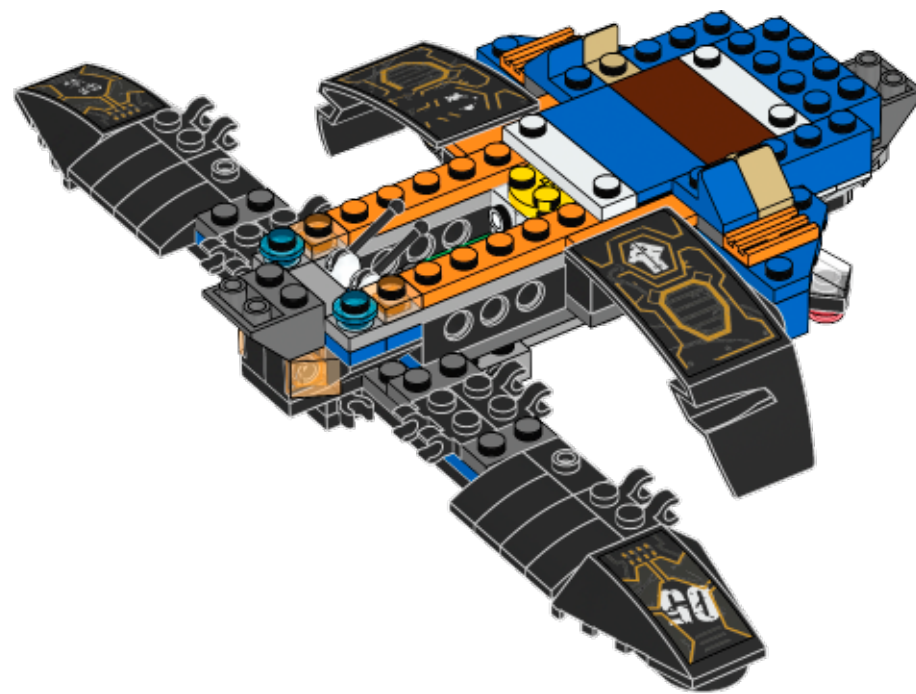

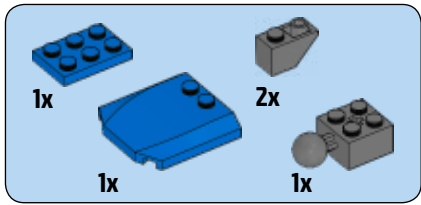

49

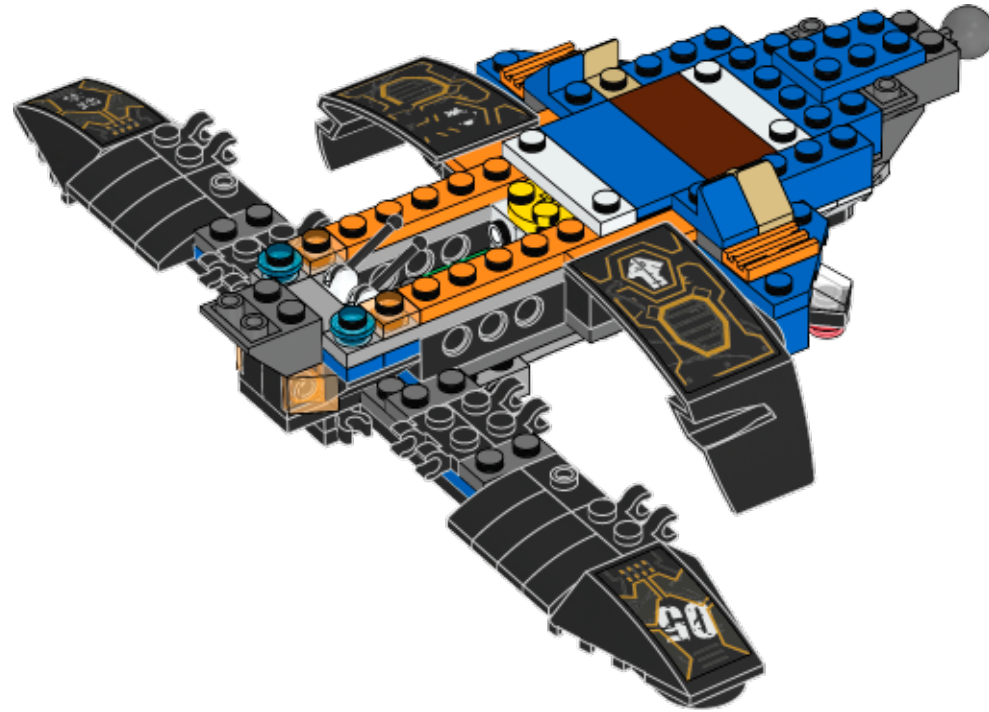
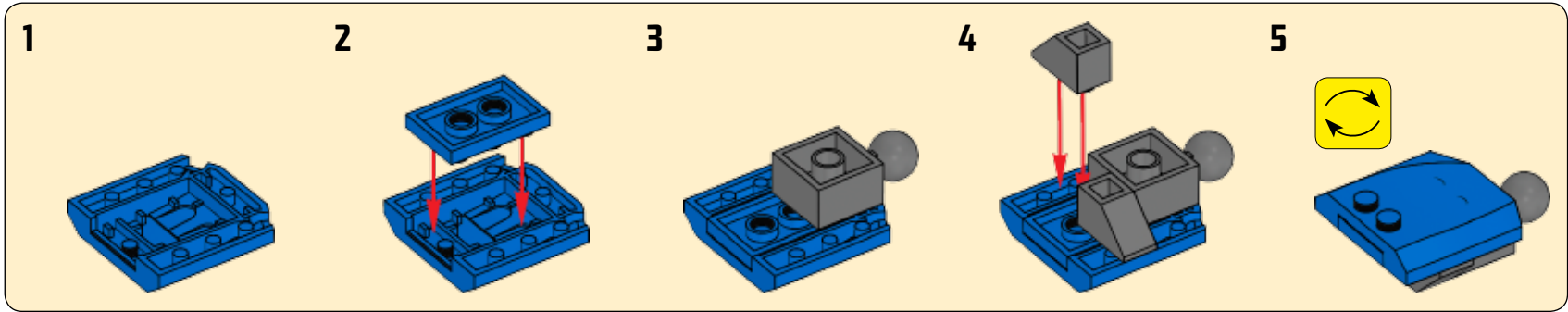

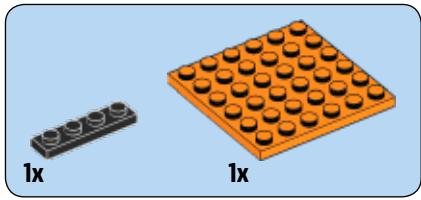

50

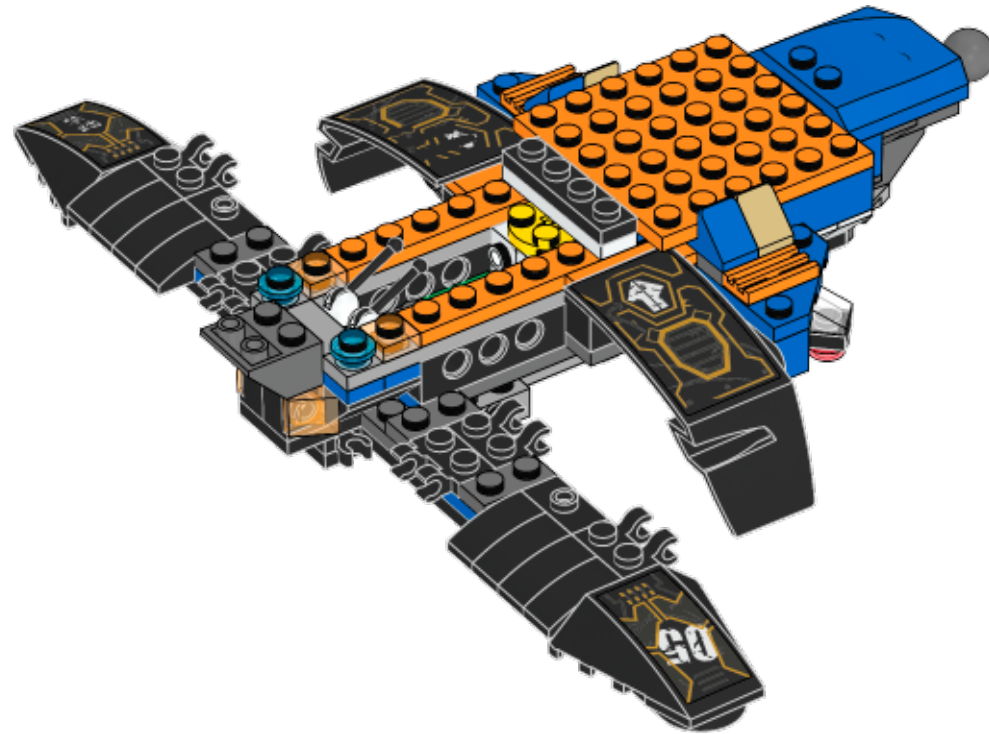

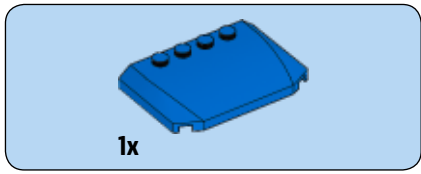

51

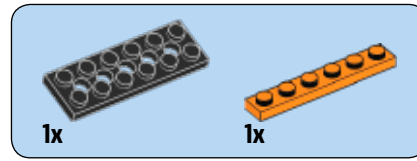
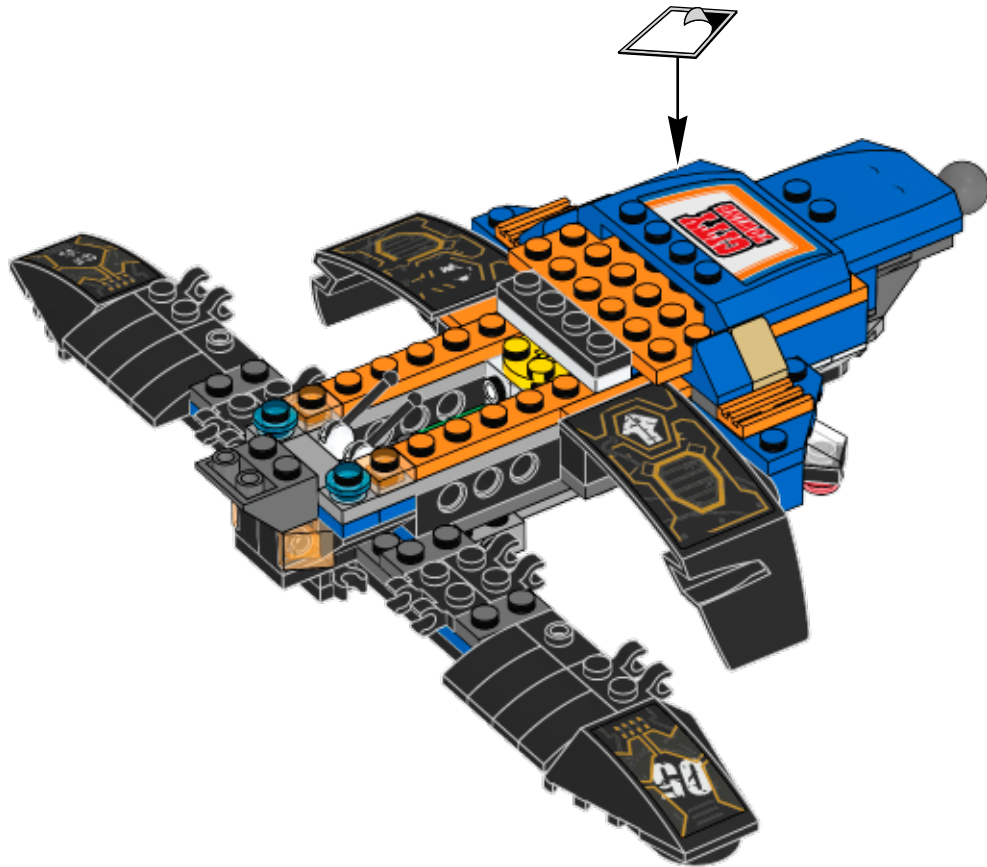

52

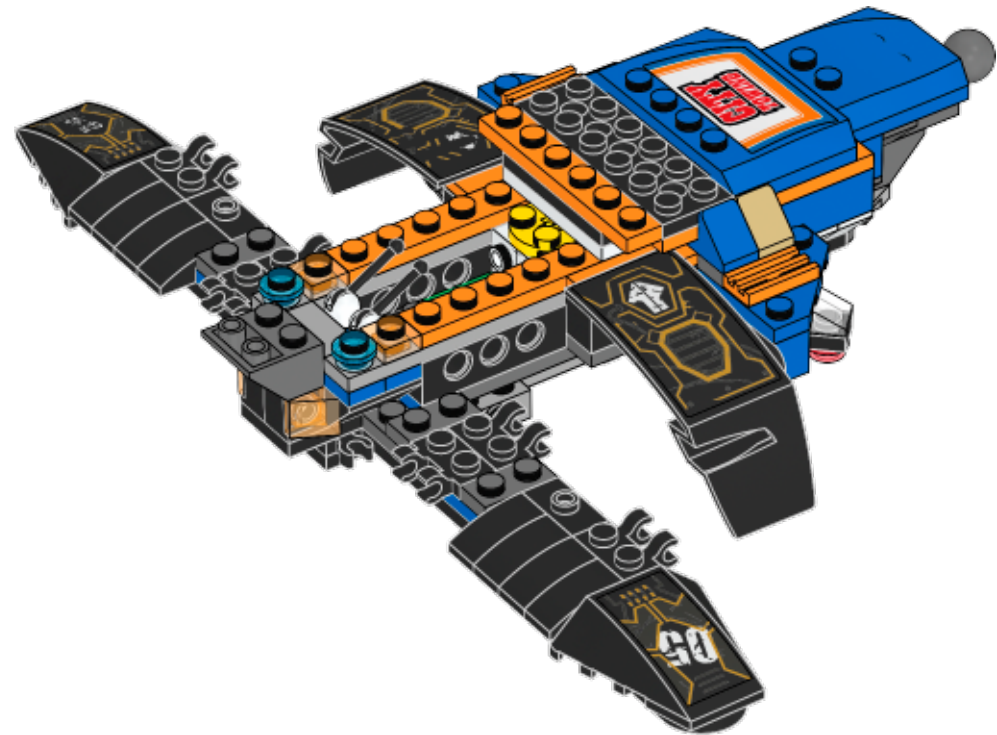



2x

53

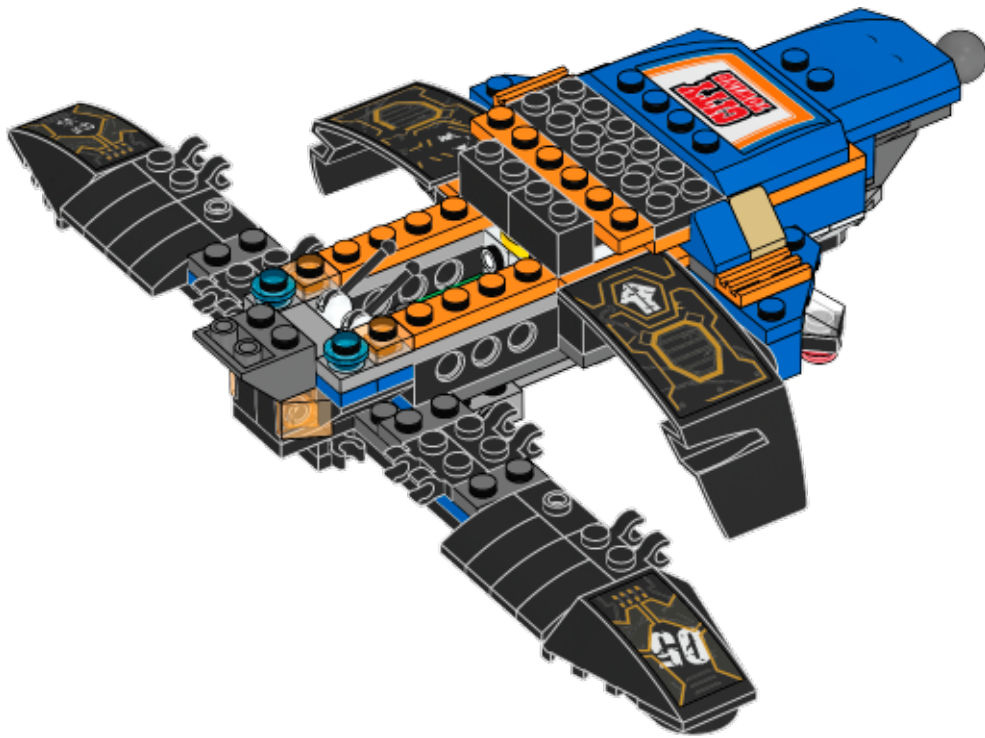

4x



1x

54

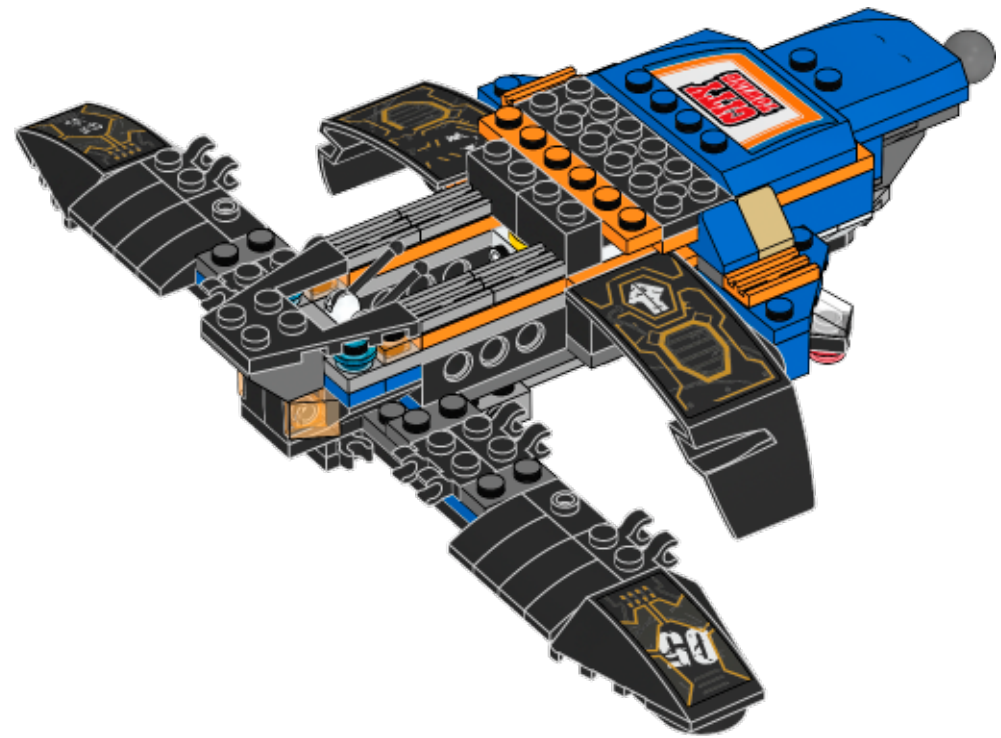



2x



1x

55

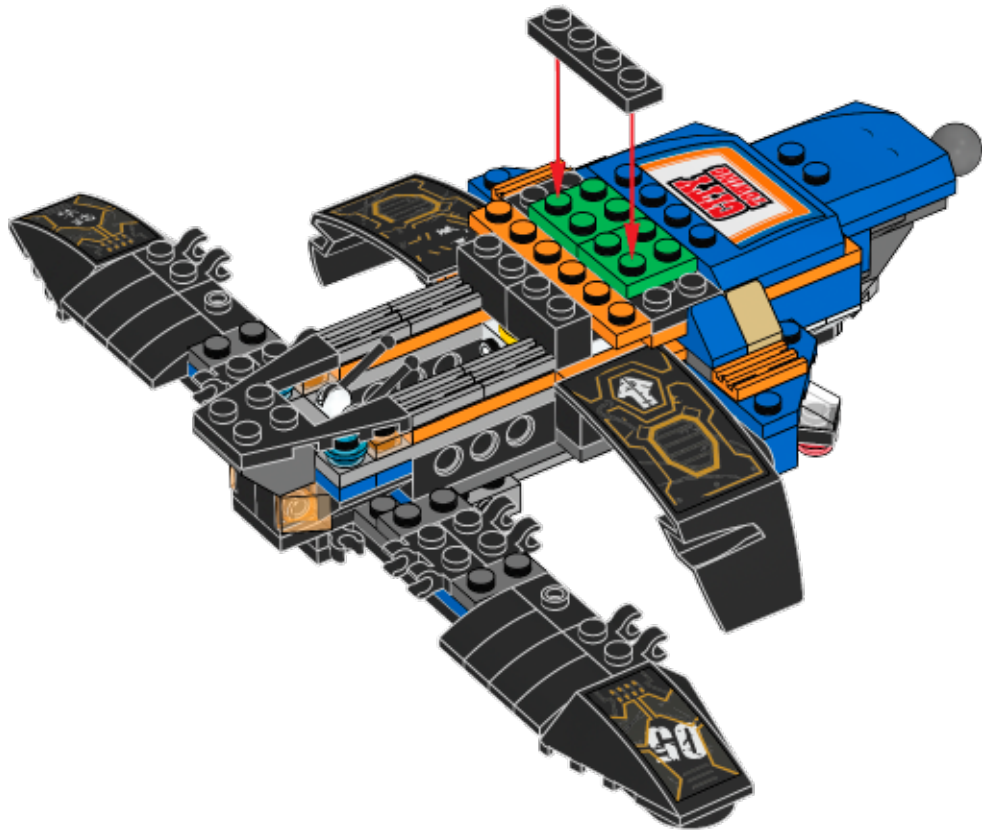

2x

56

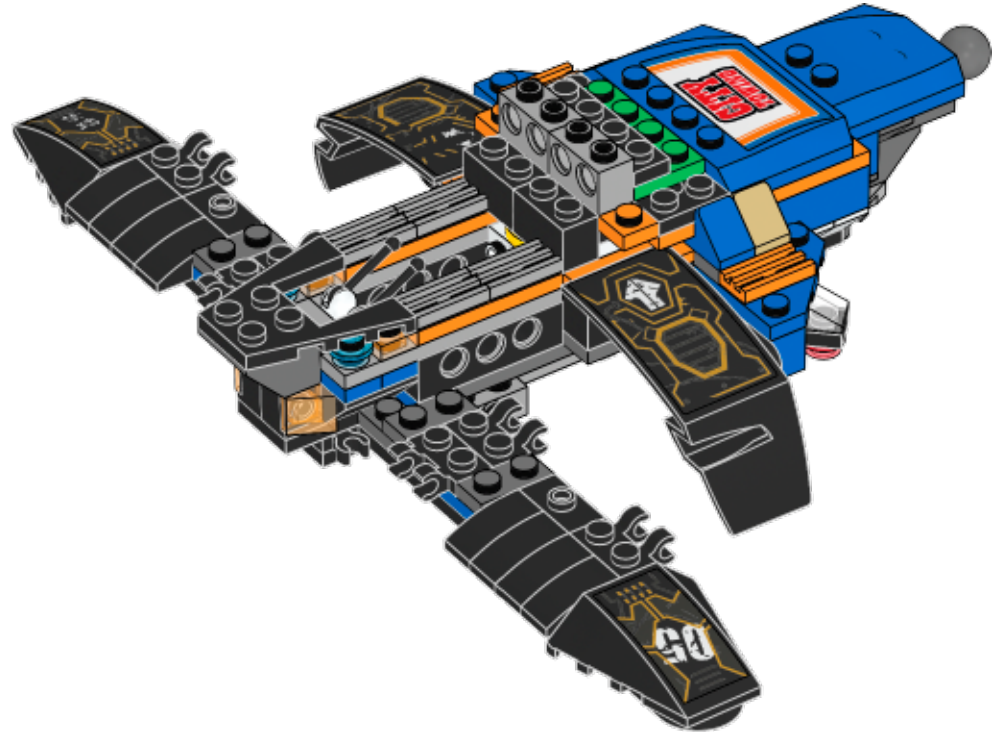



1x

57

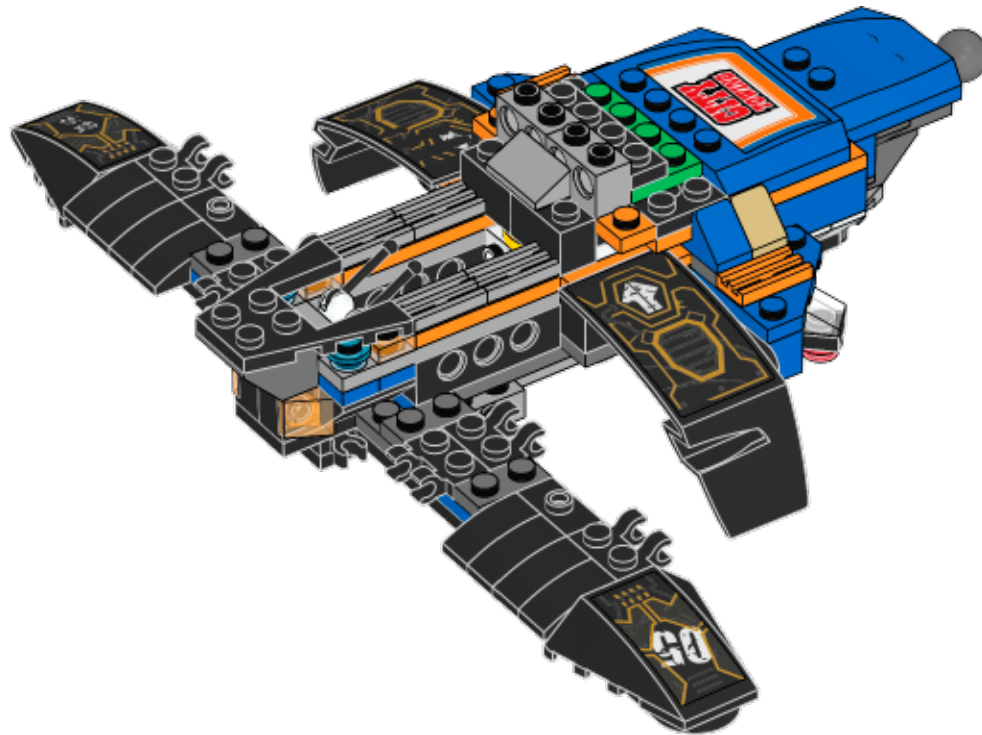

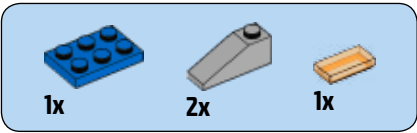

58

- 1
- 2
- 3

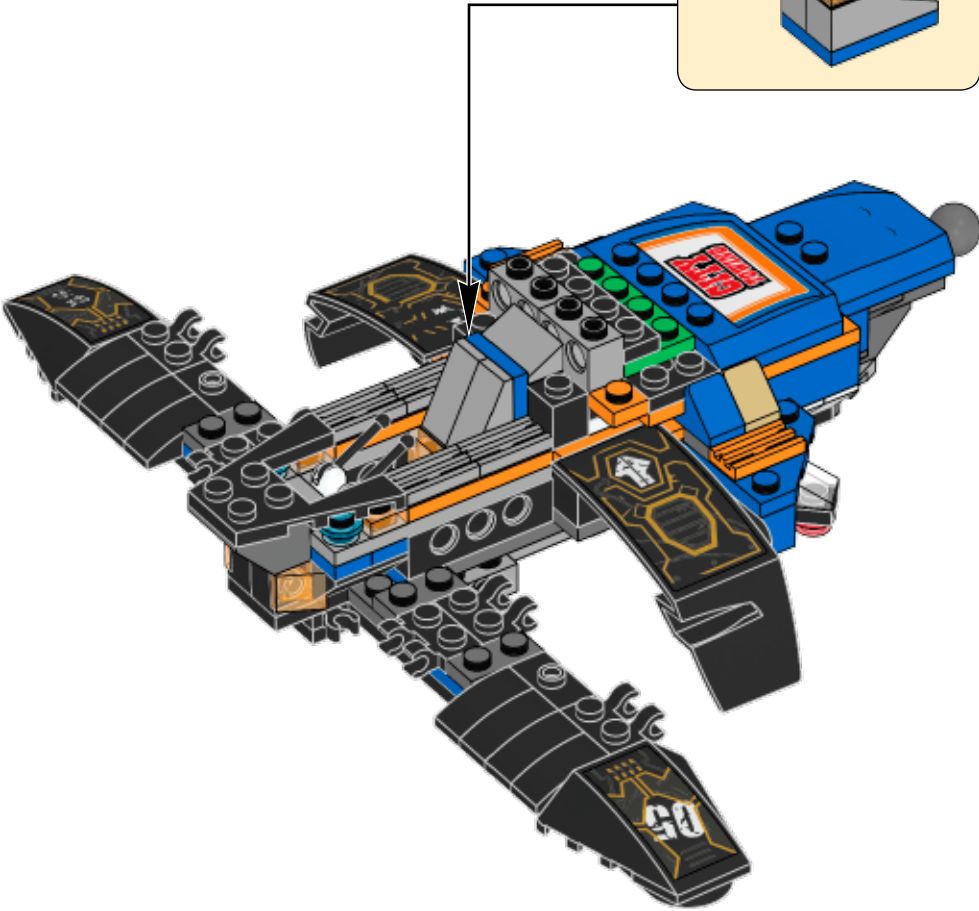

59

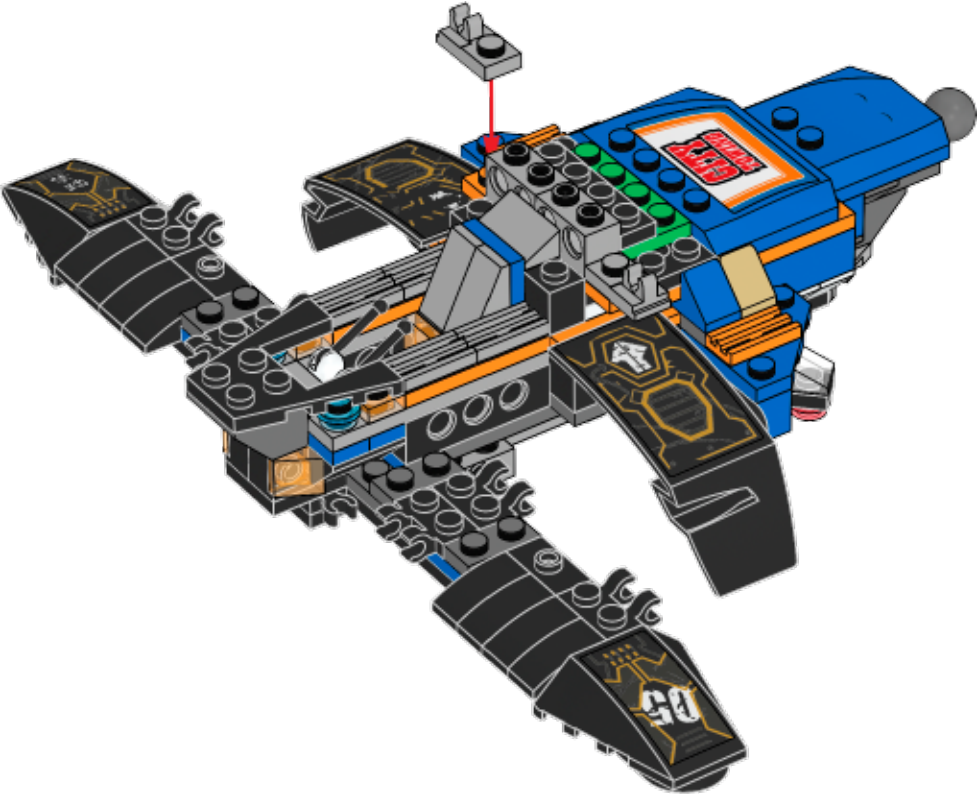



2x

60

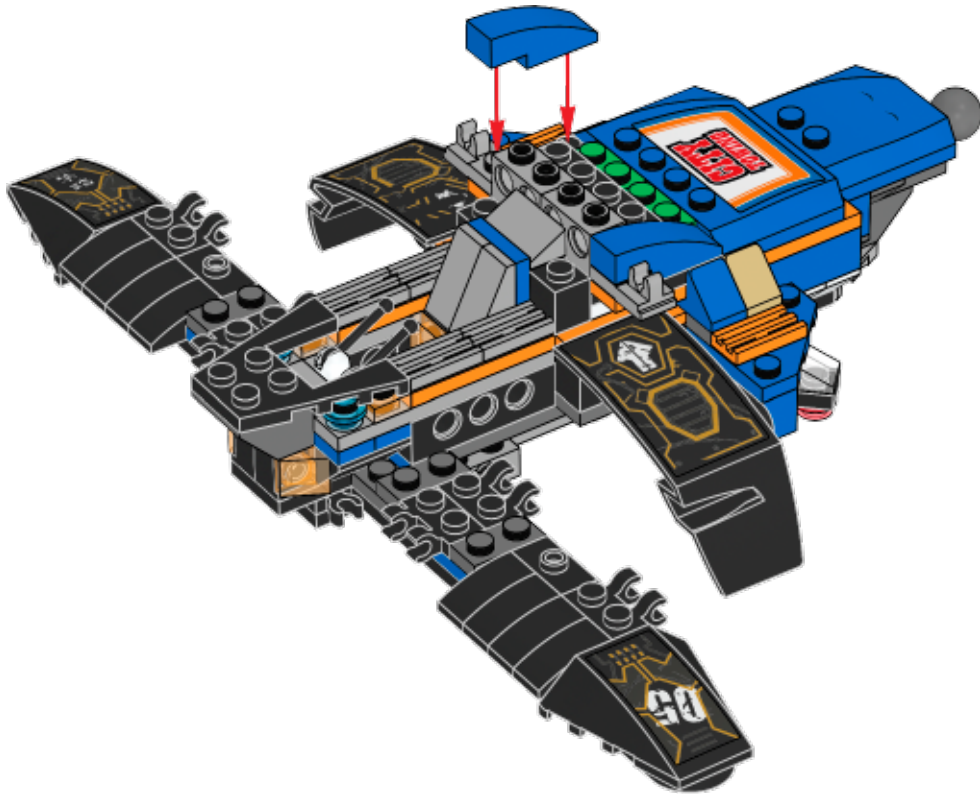

1x



2x

61

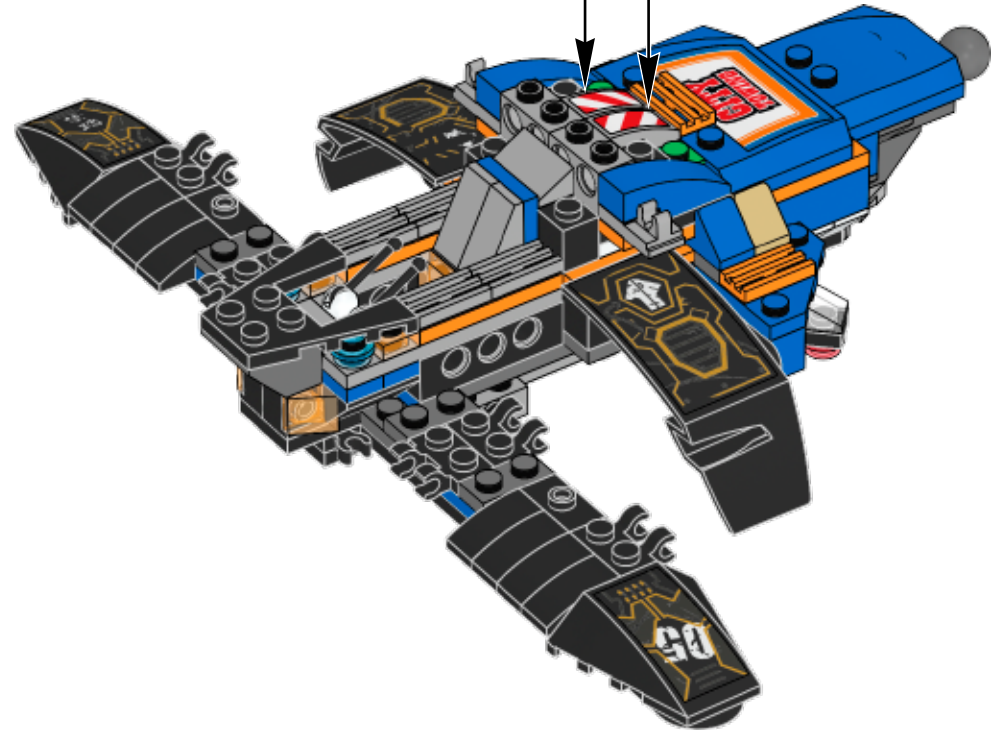
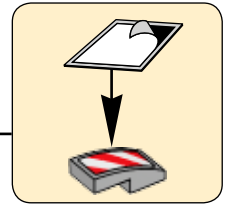
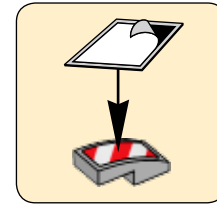



2x

62

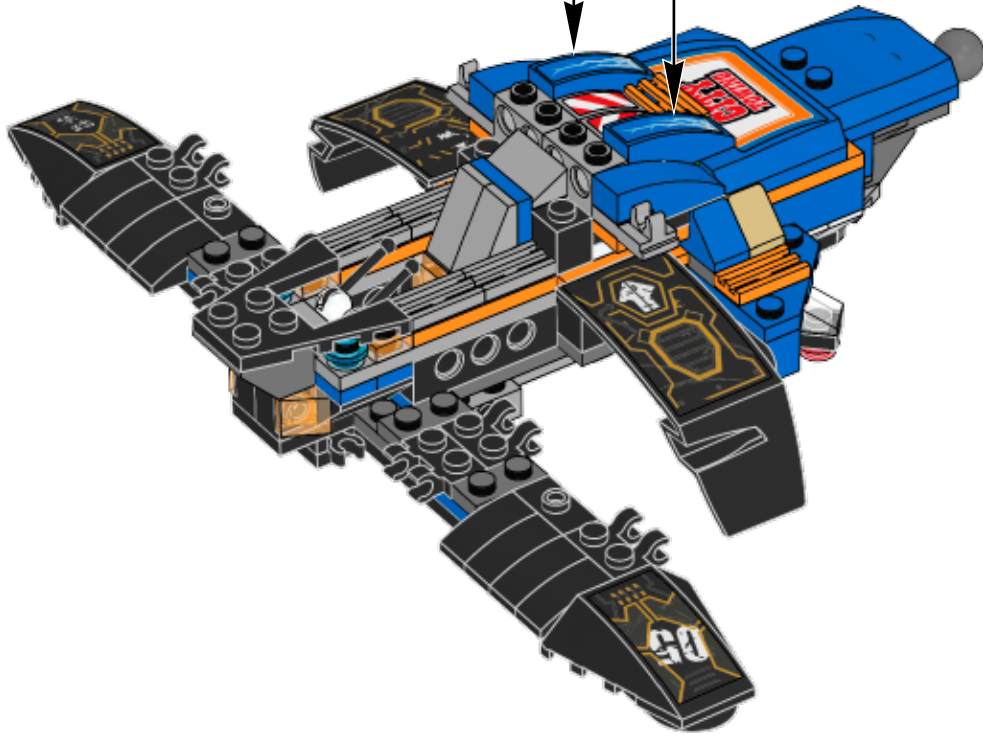
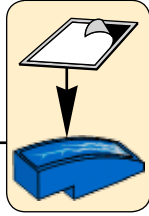
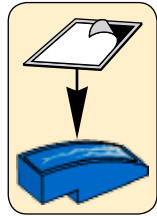

1x

63

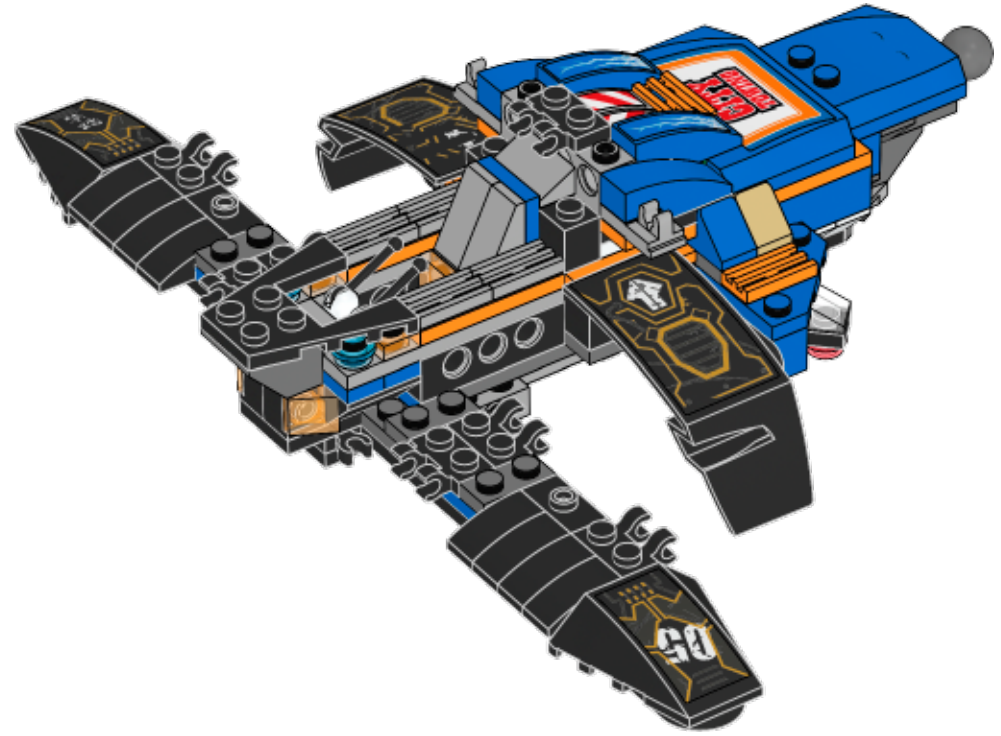



1x

64

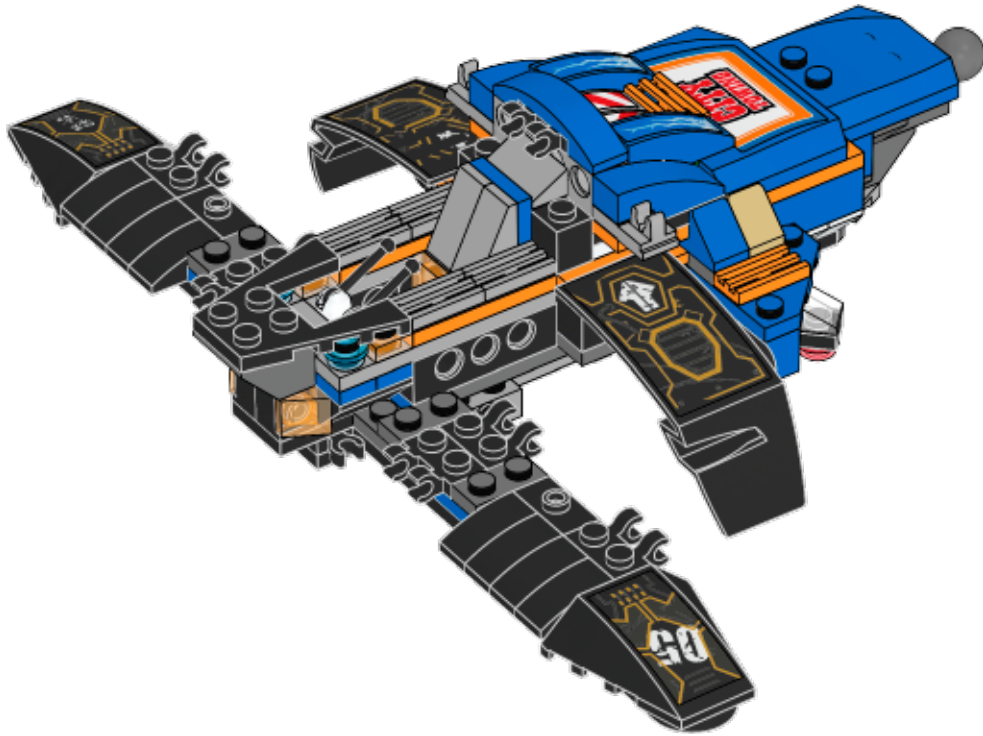

4x

65

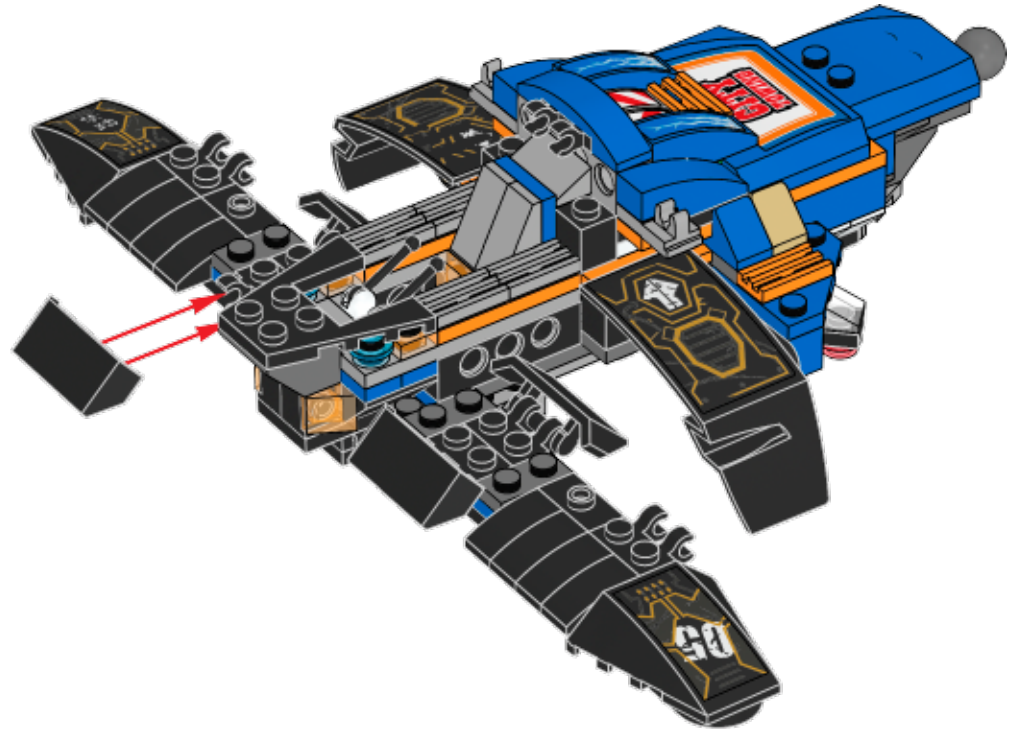

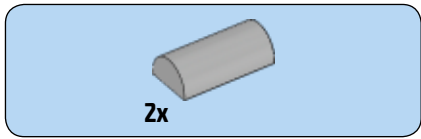

66

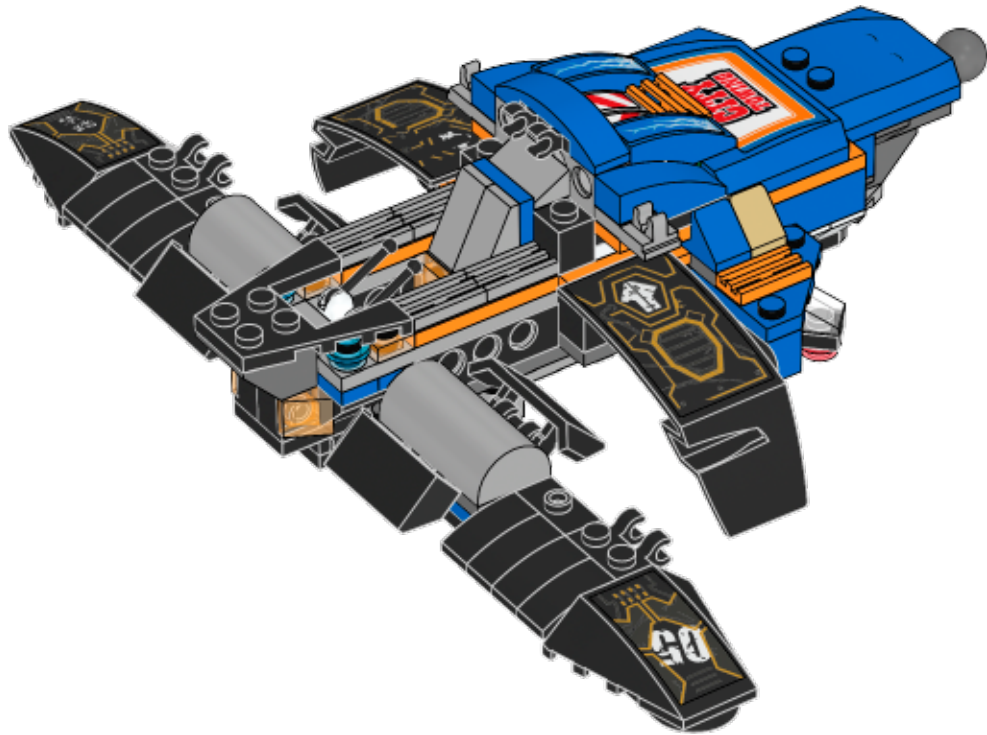

67

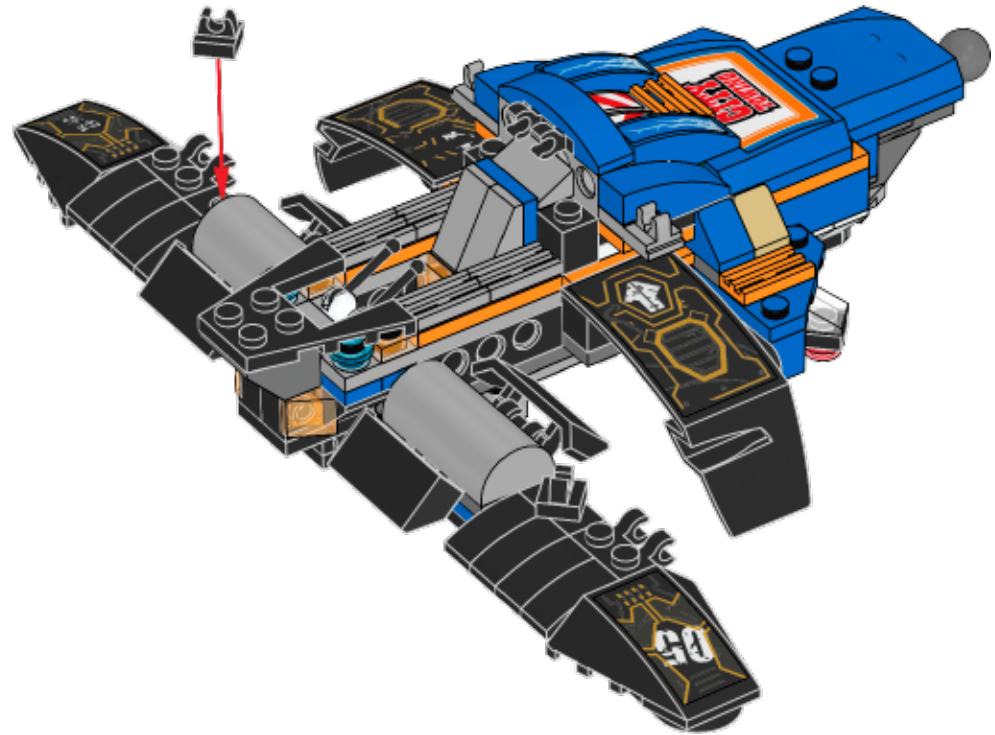

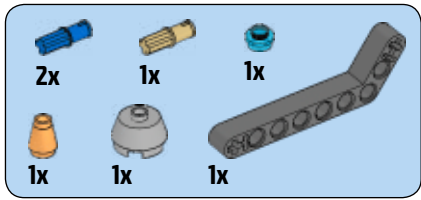

68

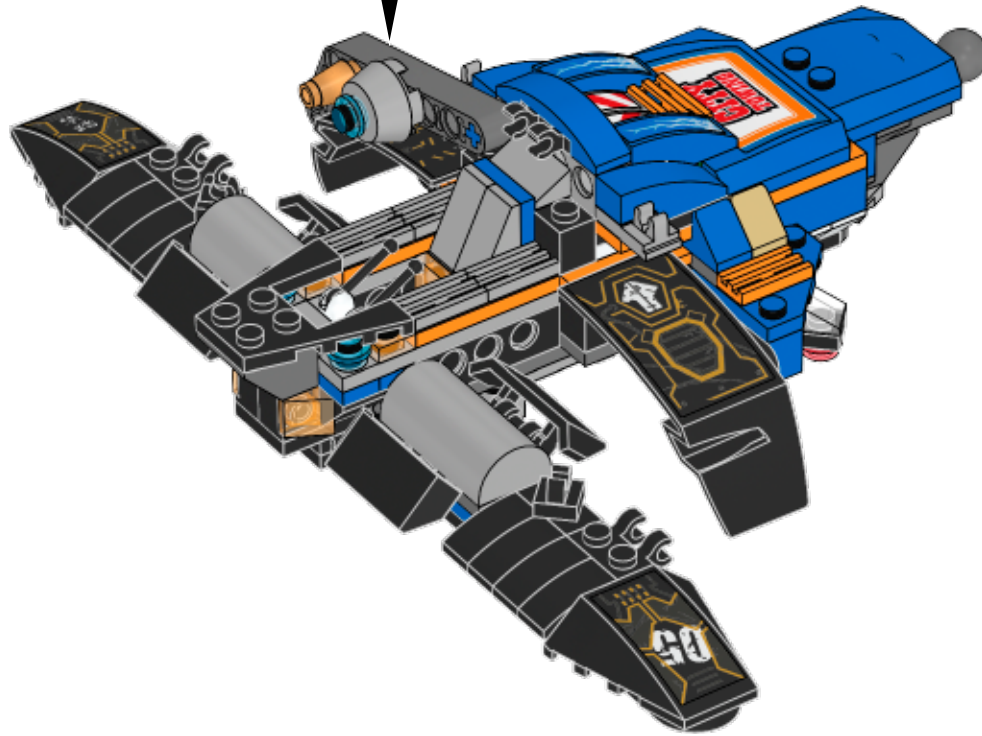
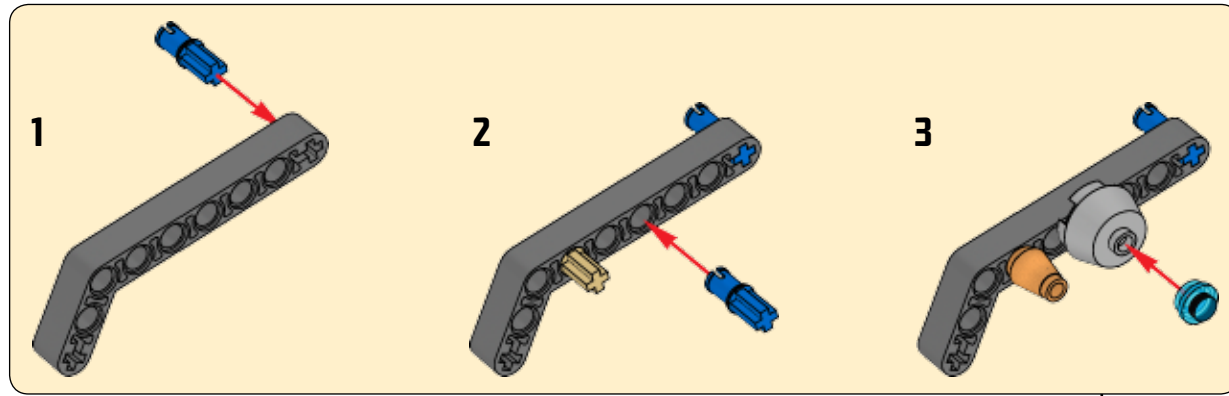

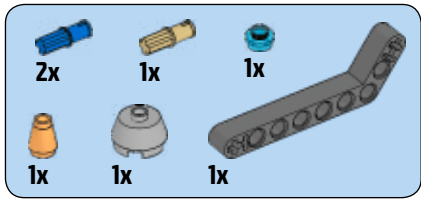

69

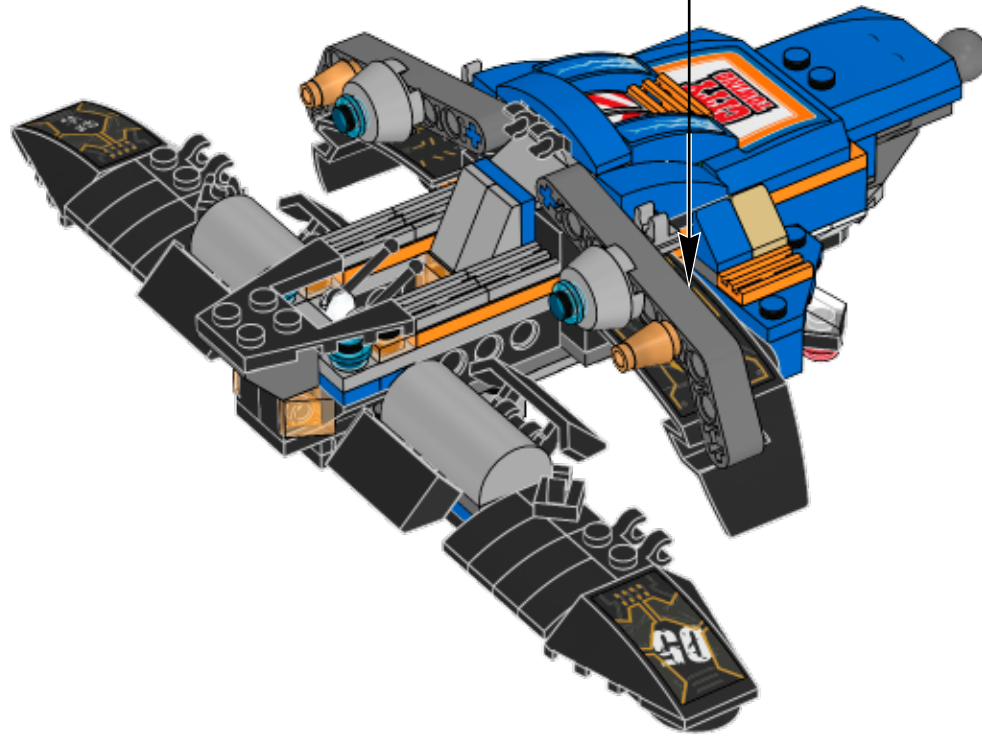
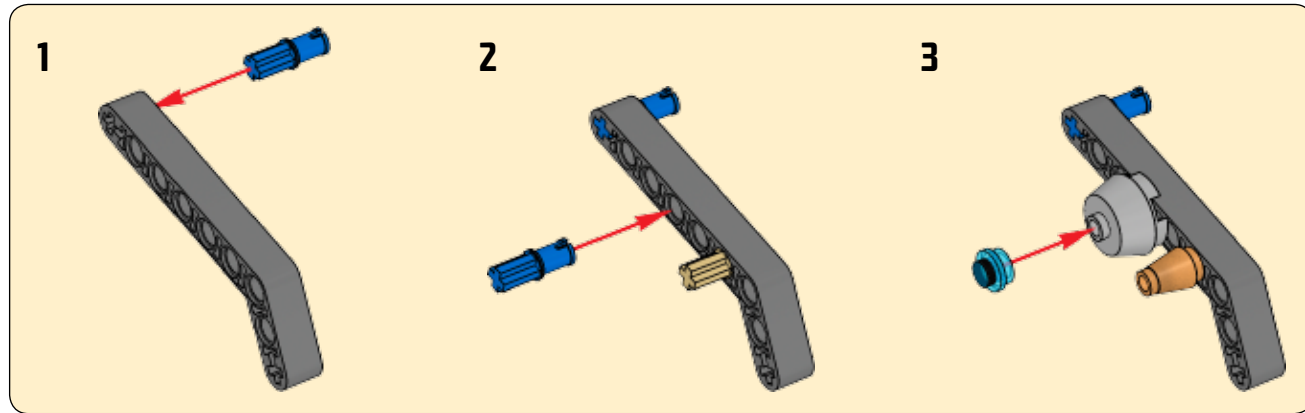

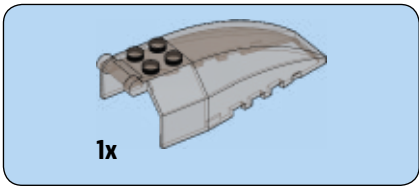

70

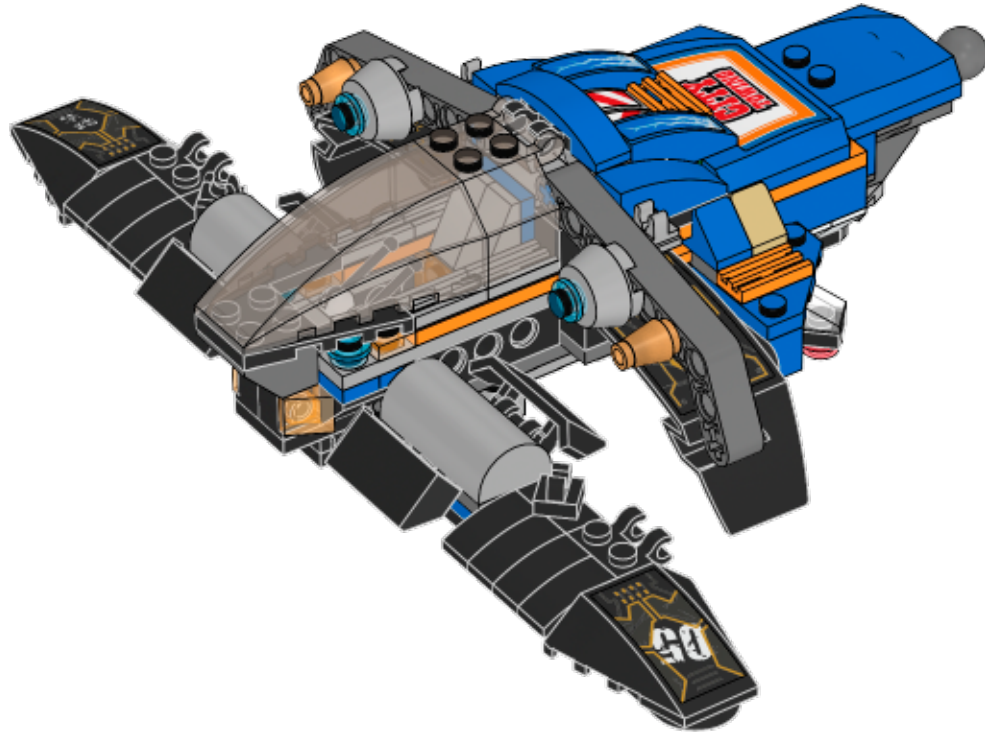

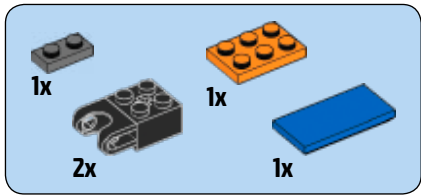

71

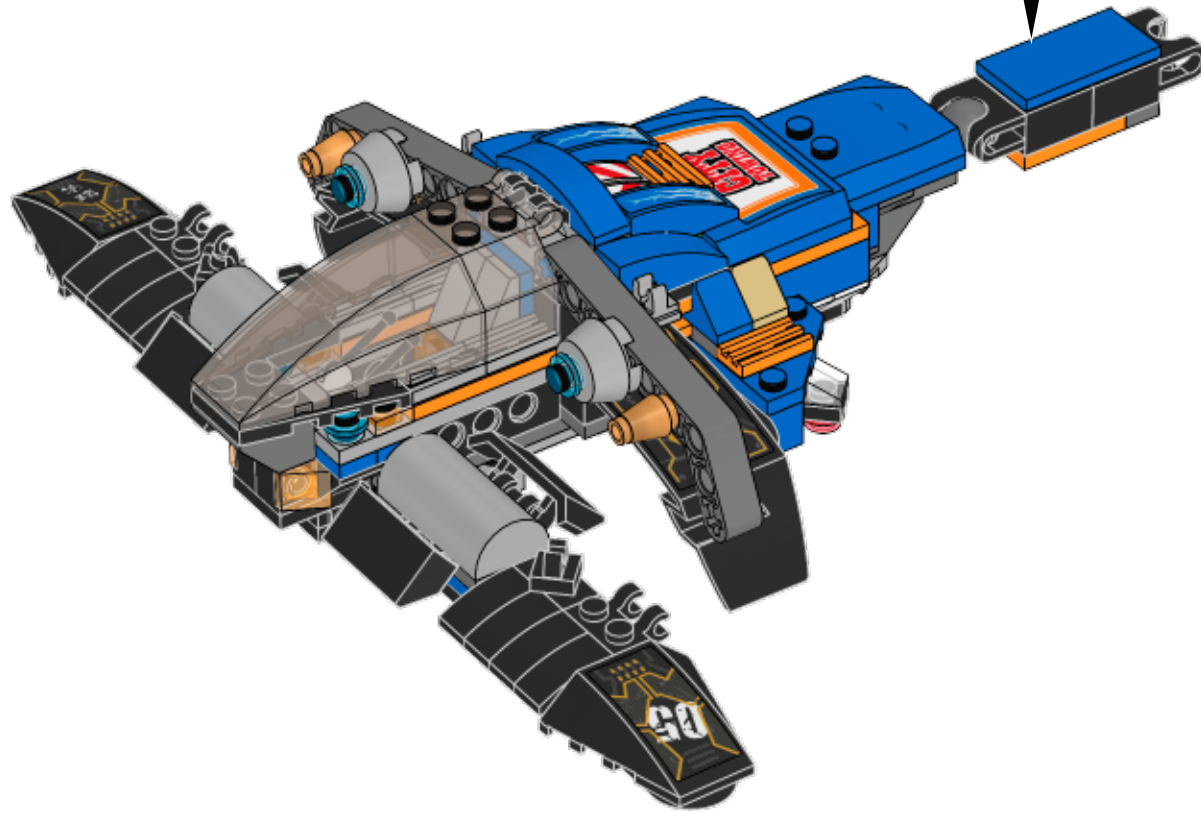
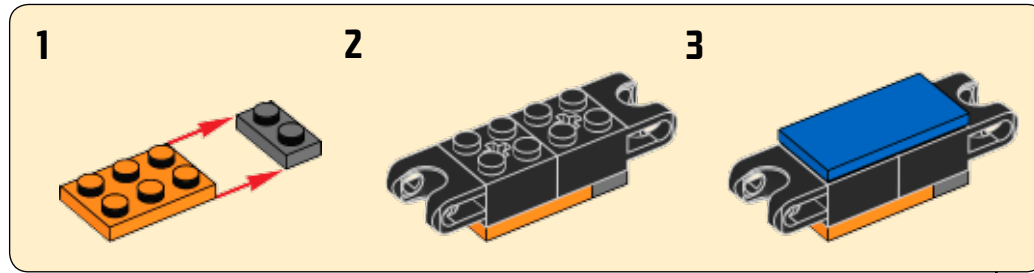

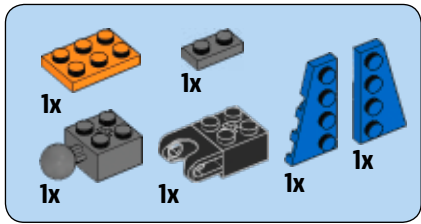

72

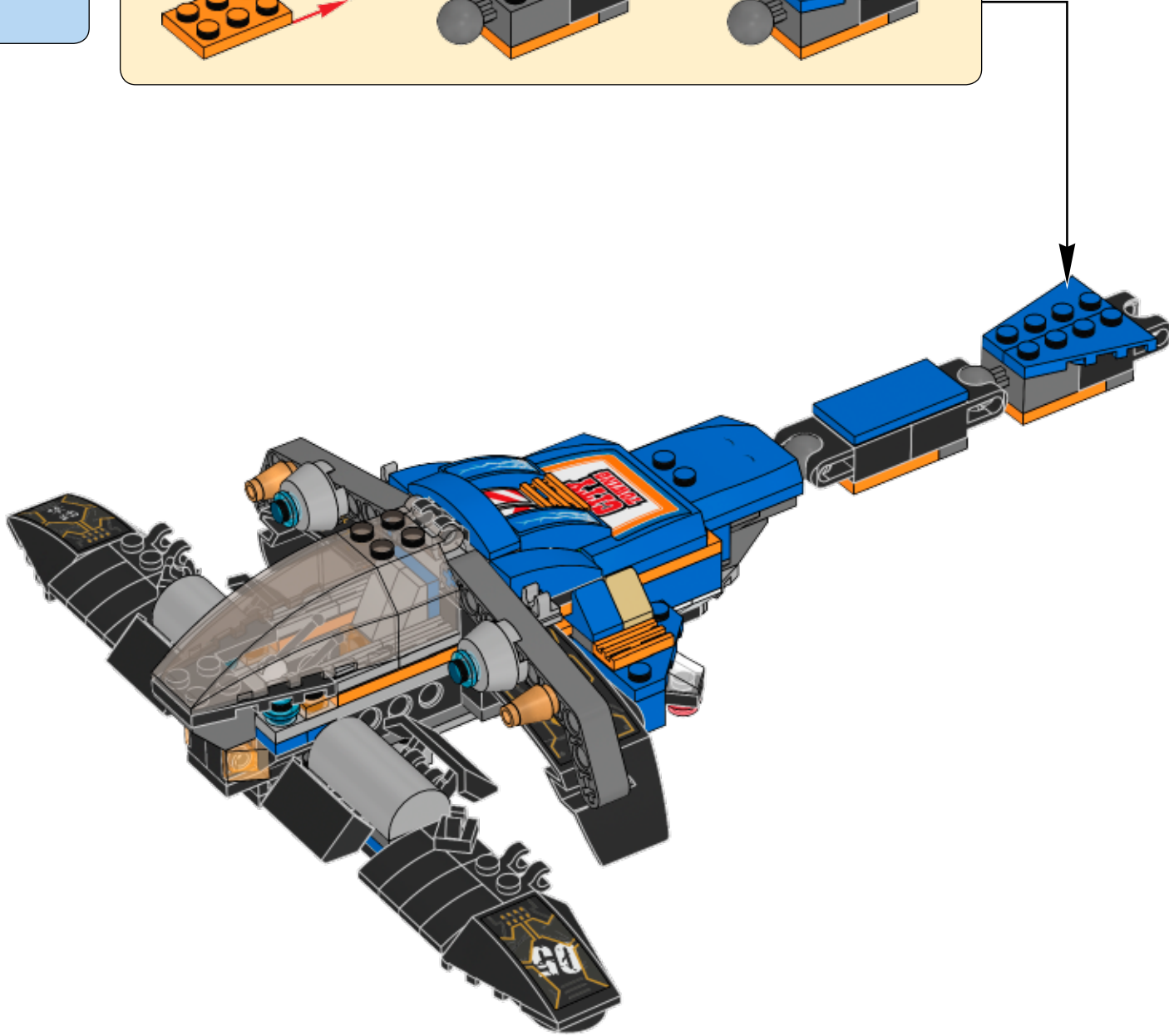
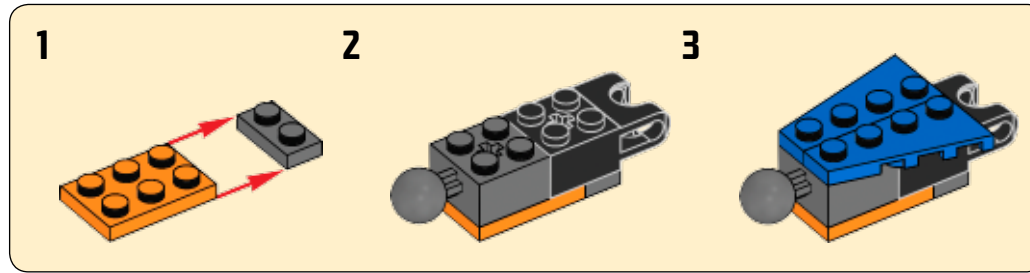



73

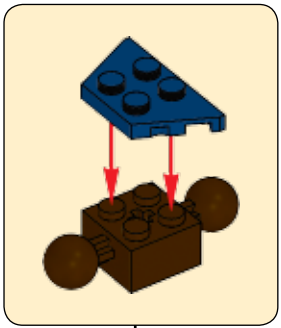

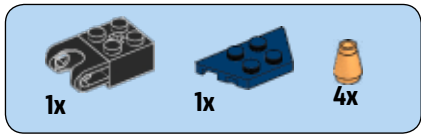

74

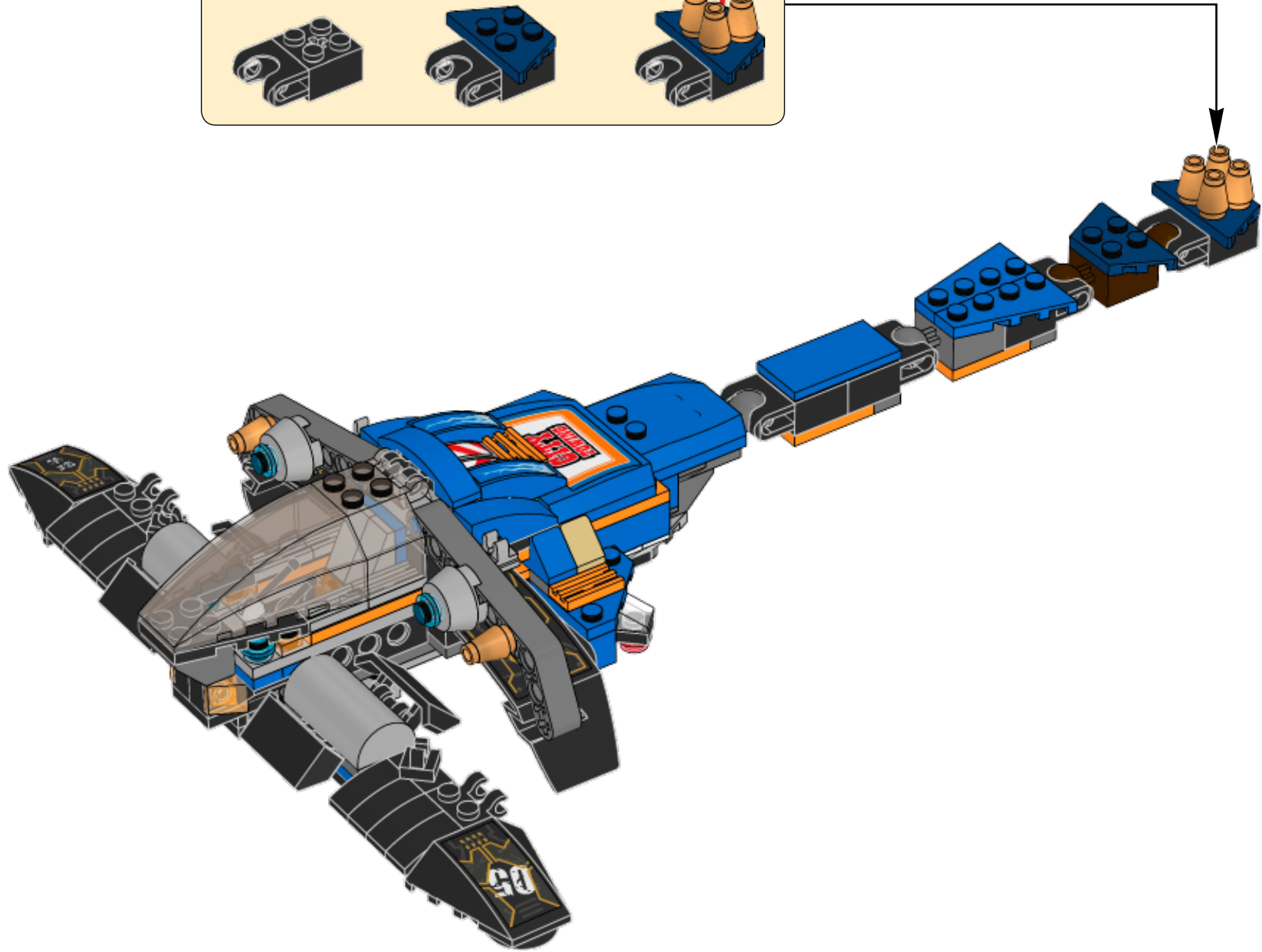
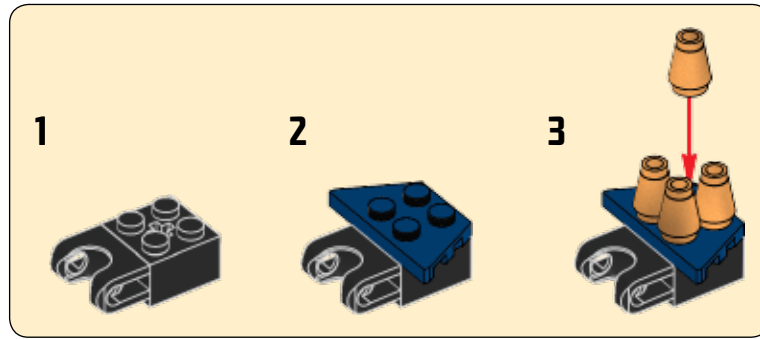

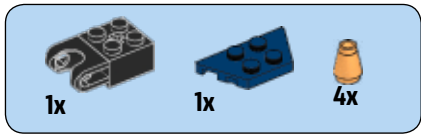

75

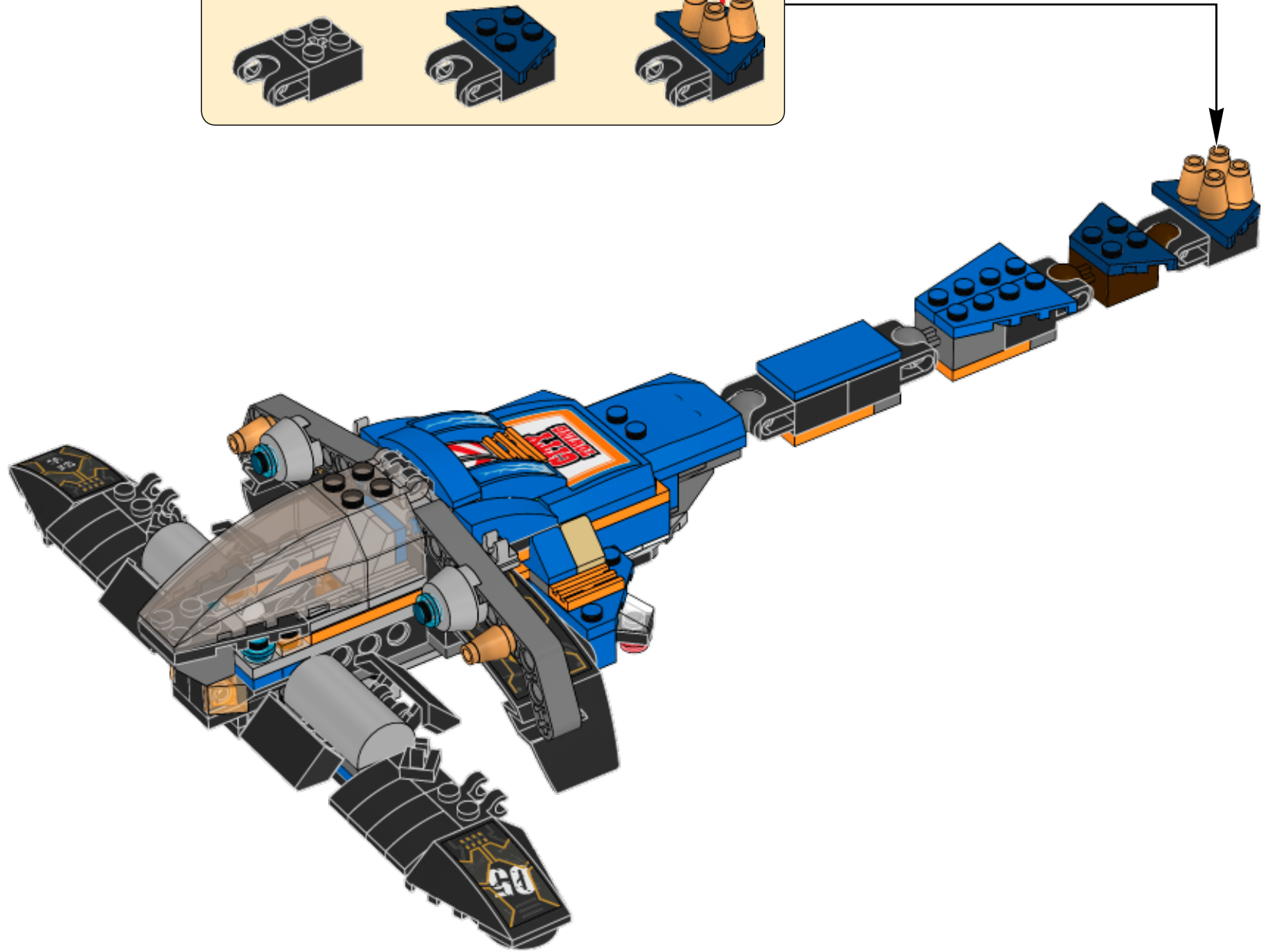
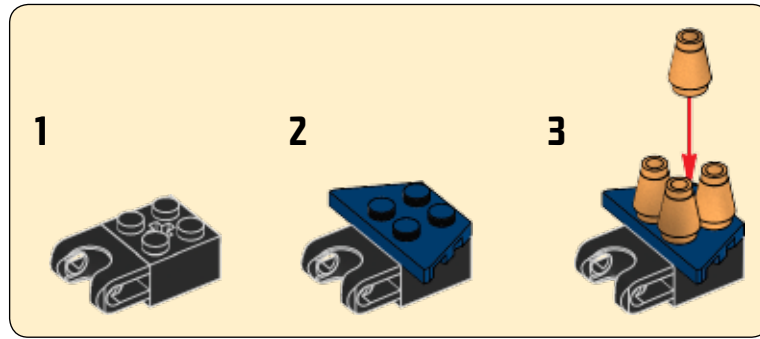

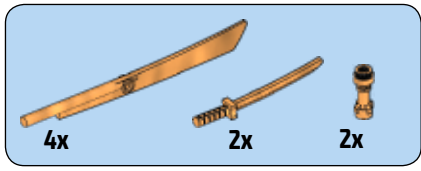

76

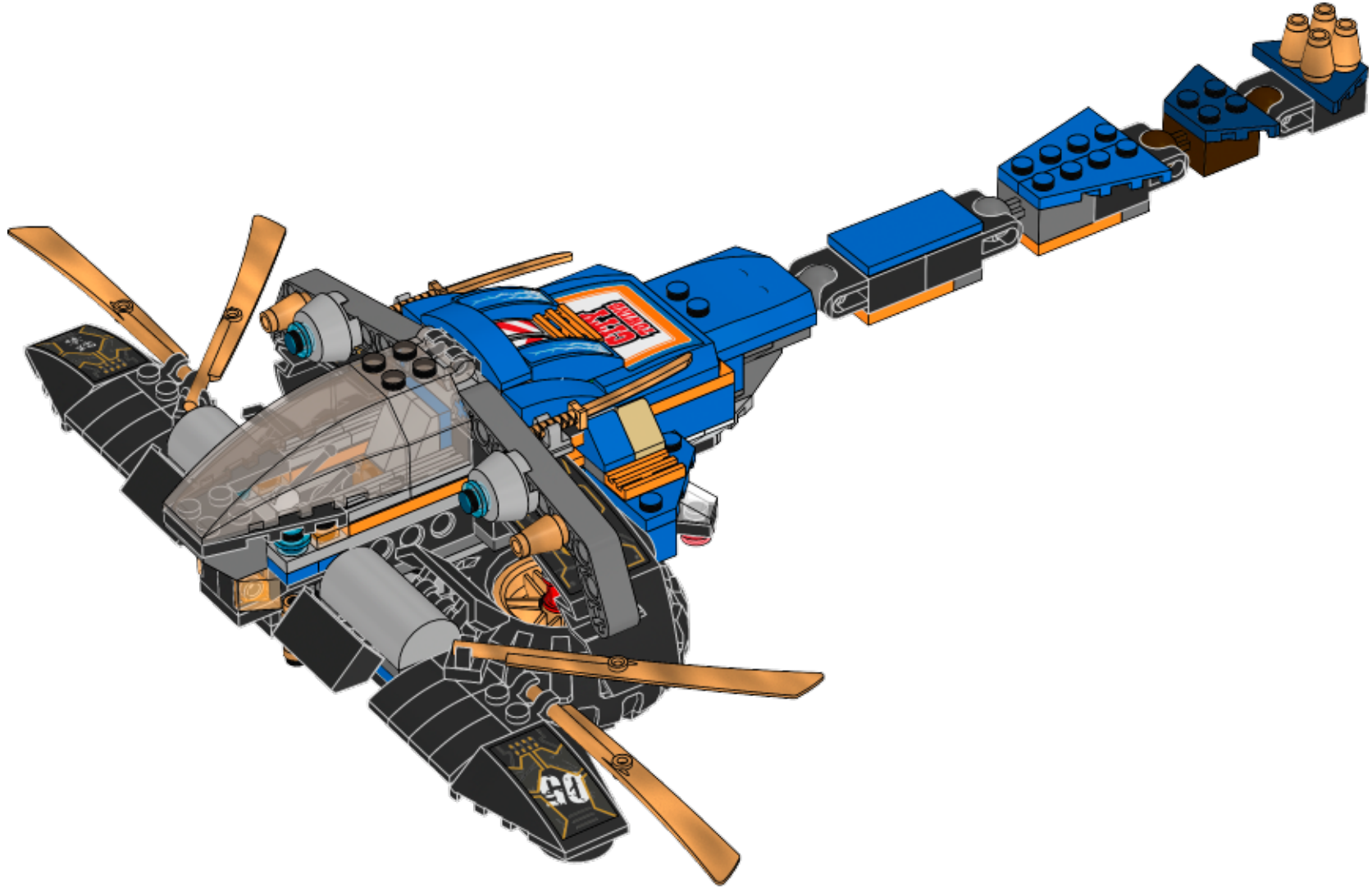

2x
4558952

4x
4259937

3x
4597131

1x
379501

2x
73737

2x
4624988

2x
4666679

2x
4514554

2x
4227155

2x
362223

1x
300123

1x
389523

2x
4620297



4x
4543998

1x
4649773

2x
302323

3x
302123

3x
371023

2x
4560180

1x
4243815

2x
379523

2x
6055414

1x
4160867

1x
4161330

2x
4609330

1x
6055328

1x
4294739

4x
4206482

3x
403224

4x
300426

2x
407026

4x
4619763

2x
370126

1x
4188534

8x
6047276

2x
4219107

2x
6092585

3x
371026

1x
303226

3x
244526

1x
428226

2x
6030718

2x
4550017

9x
4556158

2x
317626

1x
3200126

2x
6054852

2x
4561035

2x
4297209

4x
6058966

1x
6054821

1x
6054829

4x
4121715

1x
4107762

2x
302228

2x
4244362

2x
3005741

4x
614143

3x
4125254

2x
4620693

2x
4125278

4x
4173332

2x
6052391

1x
4598530

2x
6036240

2x
4613335

2x
4244369

Missing

5x
0

1x
4579690

1x
4211247

2x
6028324

2x
4211541

2x
4211488

2x
6028813

2x
4518653

5x
4211350

1x
4211414

1x
4211395

2x
4211438

2x
4598526

2x
4211568

1x
4507056

2x
6018081

2x
4211622

1x
4568637

2x
4497253

4x
4211096

2x
4211000

7x
4211063

1x
4243831

1x
4211002

1x
4210997

2x
4281516

2x
4210857

2x
6083620

3x
4211043

1x
6030534

6x
4529247

10x
4523159

2x
6003147

2x
4614404

4x
4646843

2x
4648531

1x
6092731

