

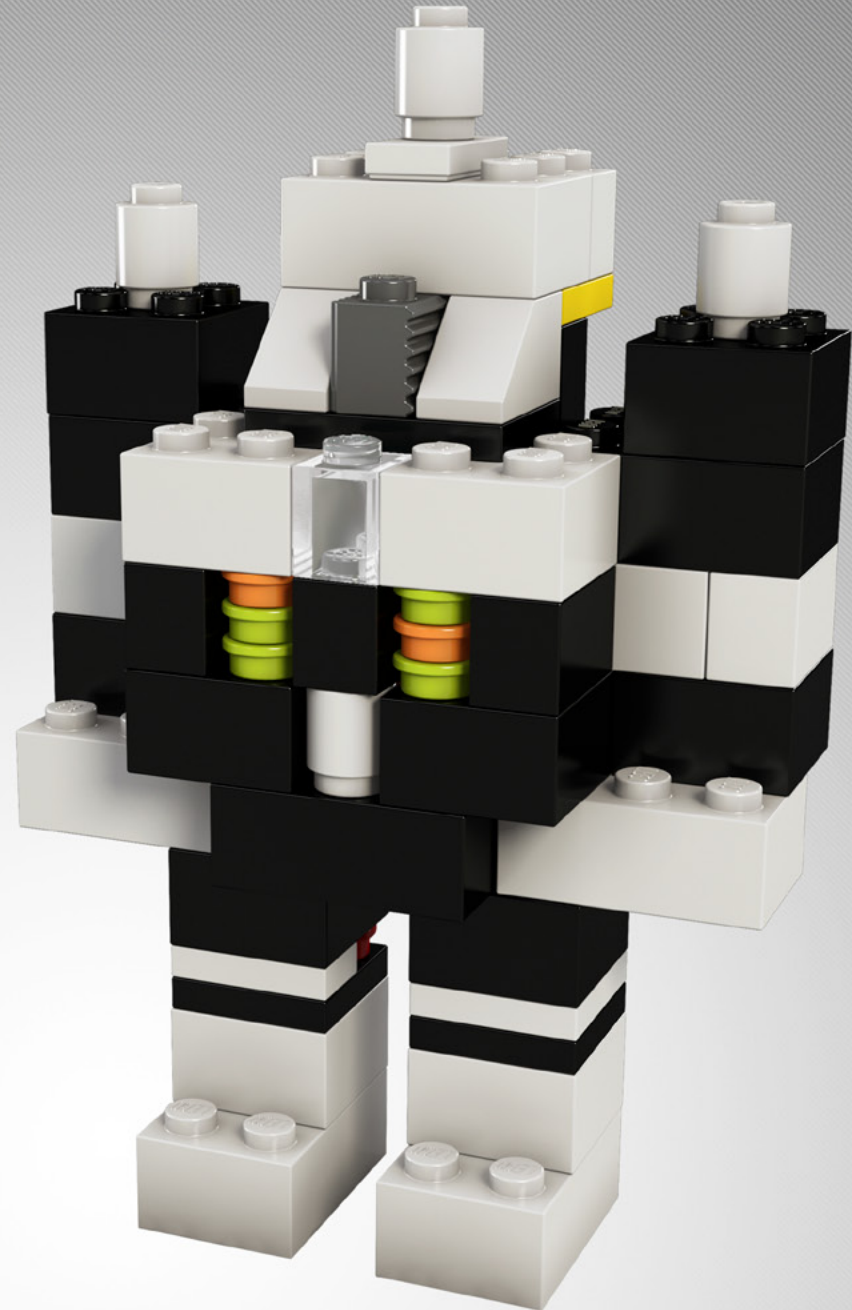

BUILD TOGETHER™

BUILD

BRICKTRON 5000













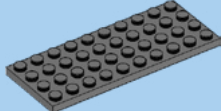















For this project, we used pieces from the LEGO® Large Brick Box (Product #6166), but you can use the bricks you have at home, in any color! Get creative with your own collection or click to learn more about the LEGO® Large Brick Box (Product #6166).



6166
LEGO® Large Brick Box



**BUILD
TOGETHER**

- | | | | |
|--|--|--|--|
| 
1x
4211122 | 
2x
4121932 | 
2x
300524 | 
3x
300126 |
| 
1x
300401 | 
2x
242001 | 
1x
302124 | 
2x
302226 |
| 
5x
300301 | 
1x
379401 | 
3x
300426 | 
1x
302126 |
| 
1x
362201 | 
1x
379401 | 
8x
300326 | 
1x
306540 |
| 
1x
362201 | 
1x
300421 | 
1x
362226 | 
2x
4157103 |
| 
6x
300201 | 
1x
362221 | 
4x
4183133 | 
1x
4210636 |
| 
4x
306201 | 
2x
614121 | 
3x
300226 | |

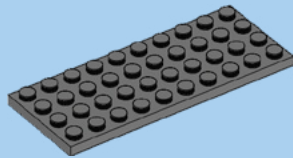

1x

1

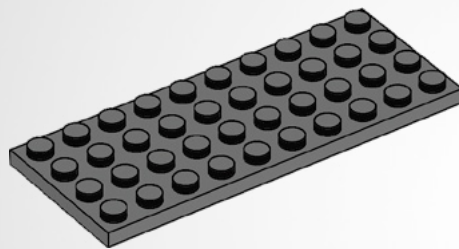

2x

2

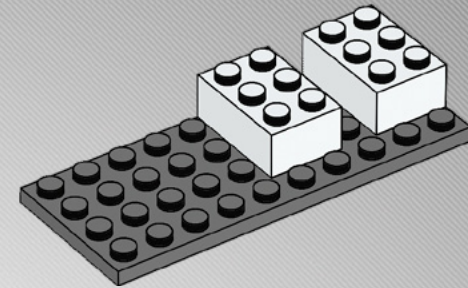

2x

3

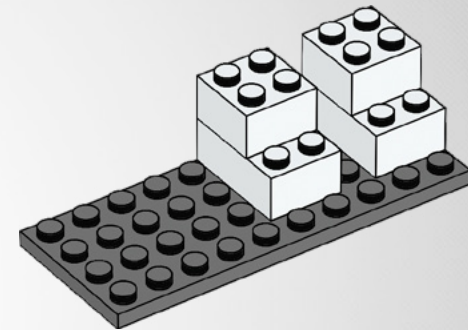



**BUILD
TOGETHER**

4



2x

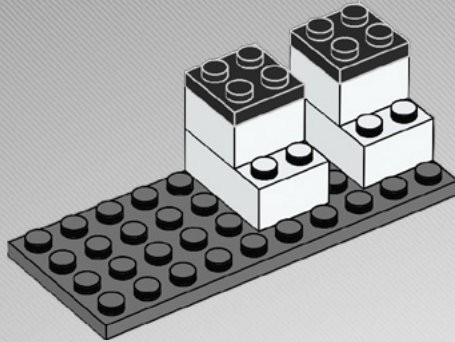

2x



2x

5

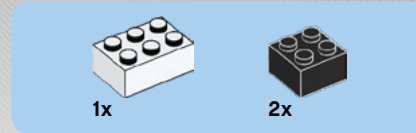
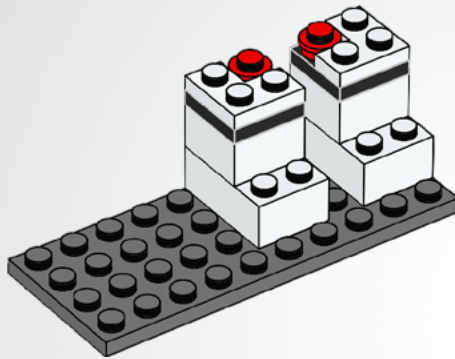

1x

2x

6

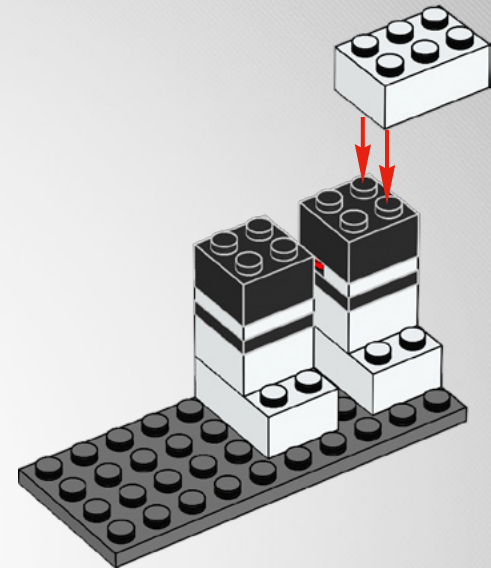



**BUILD
TOGETHER**



1x

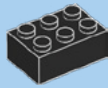

2x

7

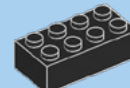
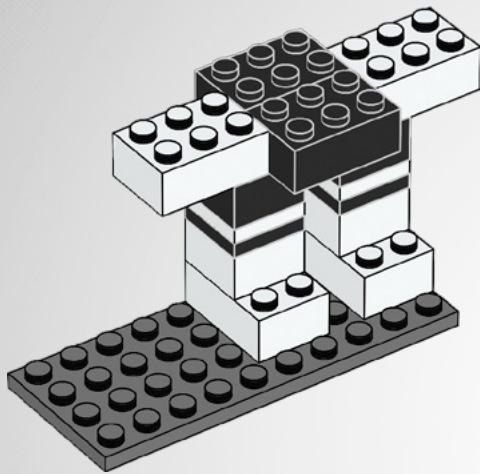

1x

8

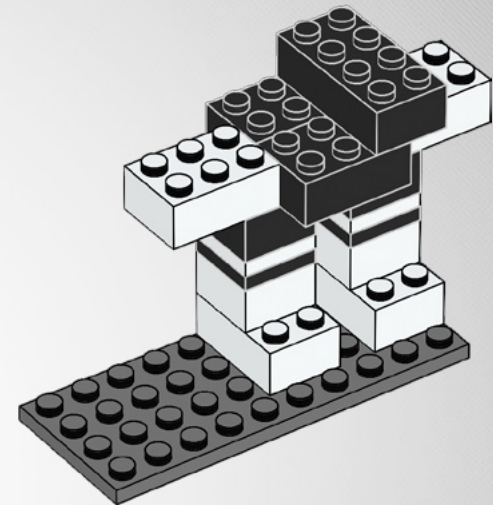



**BUILD
TOGETHER**



9

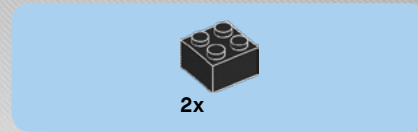
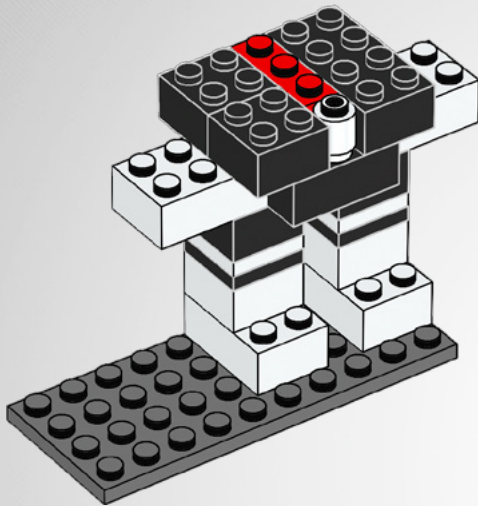

10

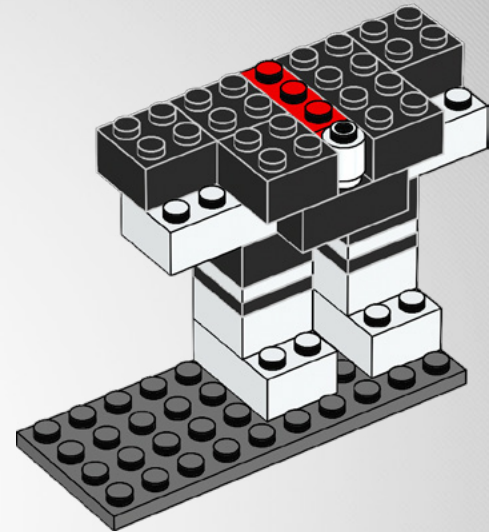



**BUILD
TOGETHER**

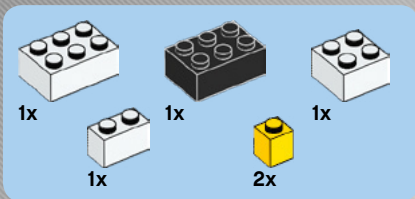

11

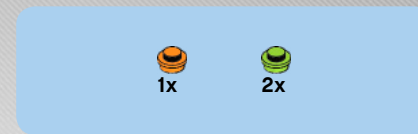
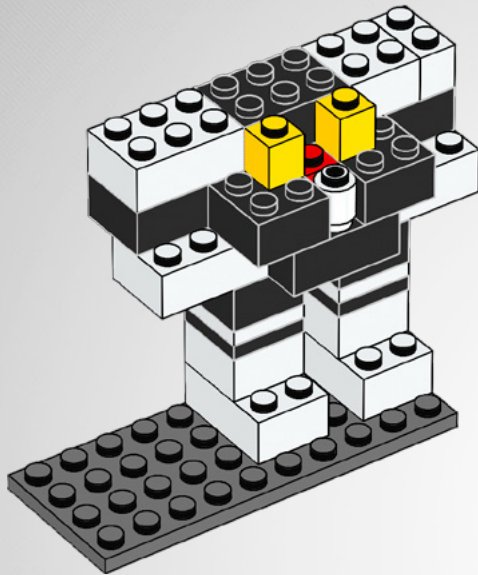

12

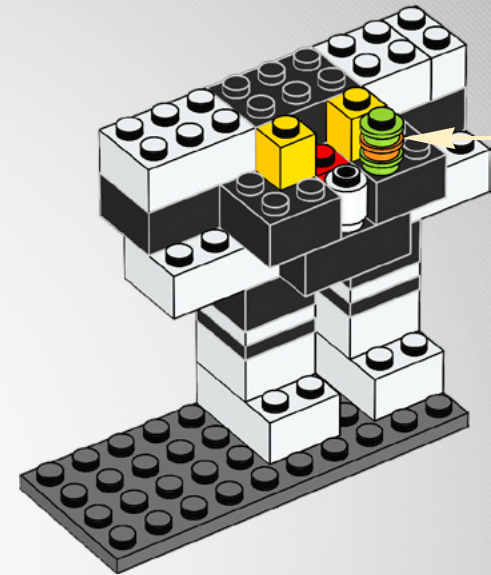
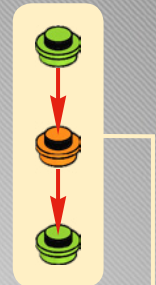



**BUILD
TOGETHER**



1x



2x

13

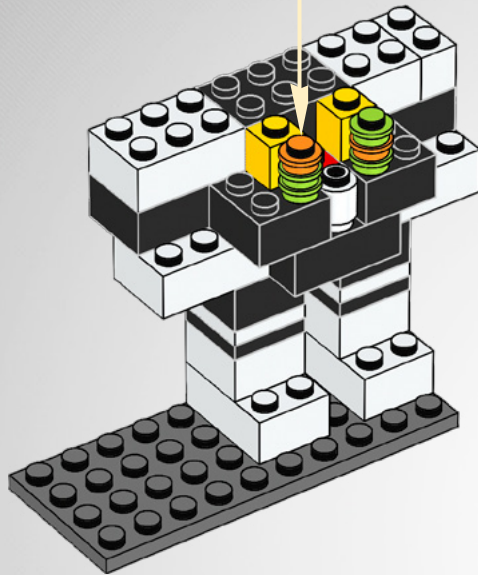

14



3x

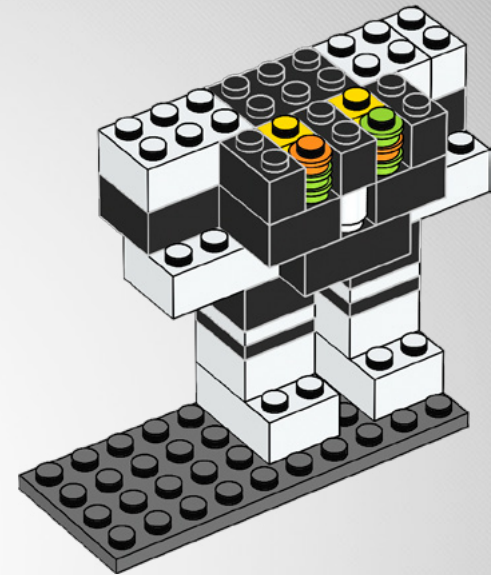



**BUILD
TOGETHER**

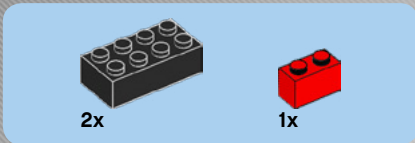

15

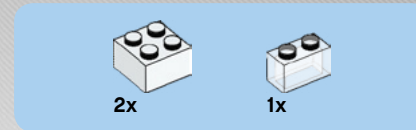
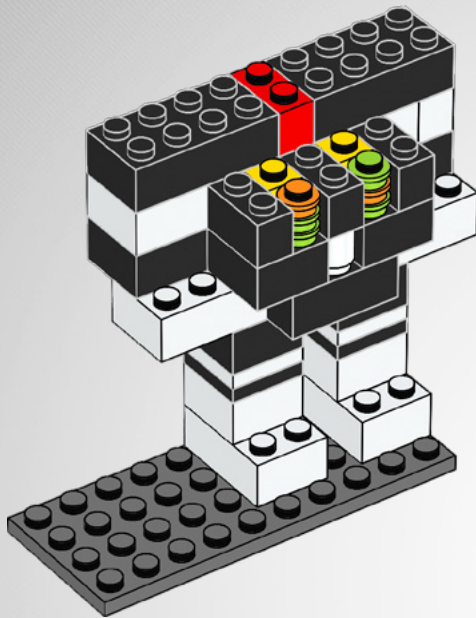

16

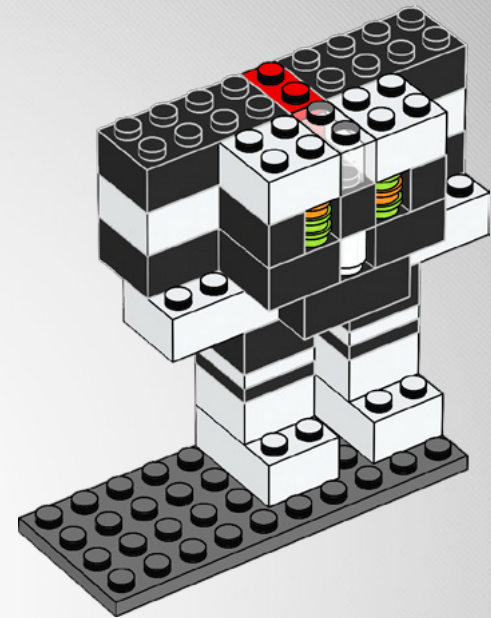



**BUILD
TOGETHER**

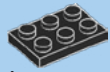

1x



1x

17

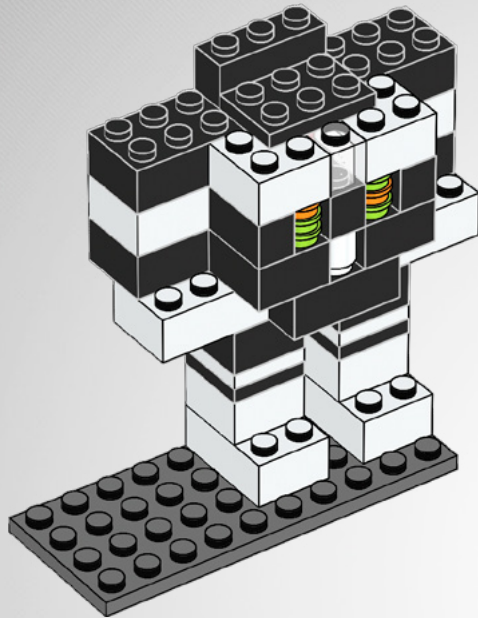

2x



1x



2x



1x

18

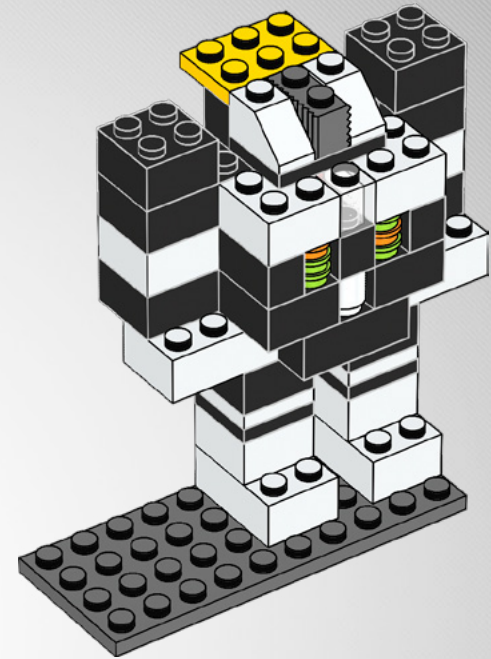



**BUILD
TOGETHER**

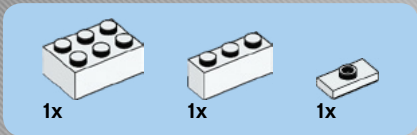

19

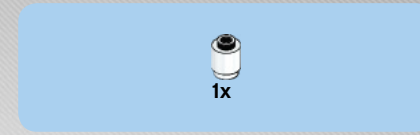
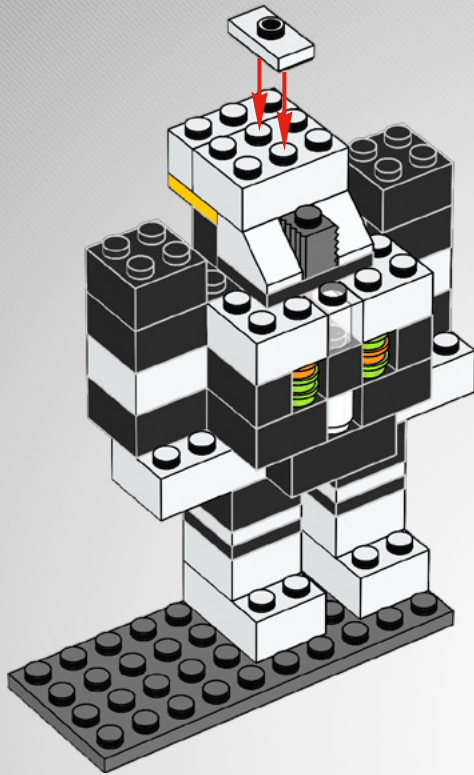

20

