

# BUILD THE CRUSHTACEAN!

With its powerful claws and armor plating made from Atlantean salvage, this hybrid vehicle was built to help the Atlantis Deep Sea Salvage Crew fight off the Shadow Snapper and other guardians of Atlantis in their hunt for undersea treasure.

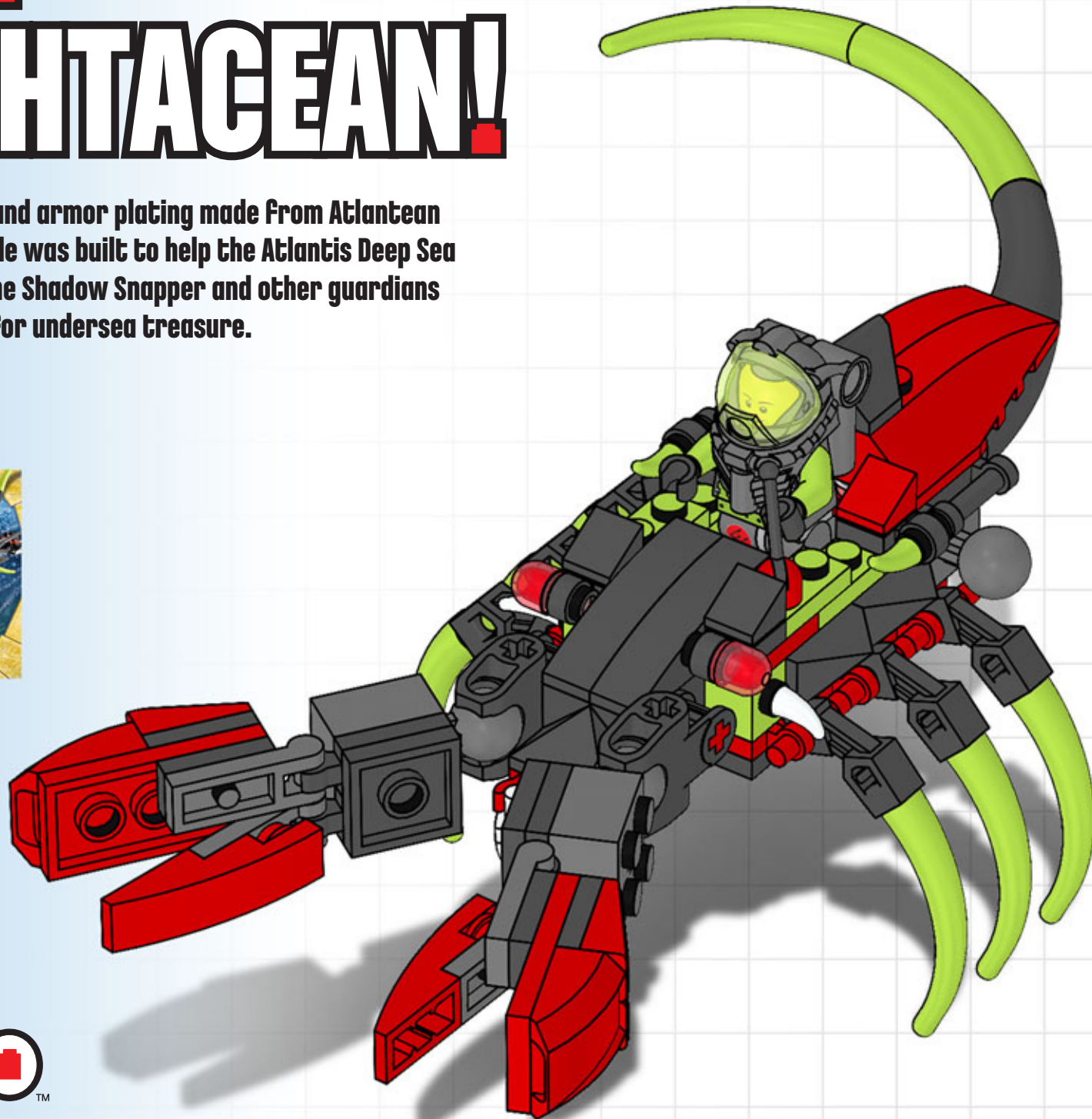

You can build the  
Crushtacean using  
pieces from 8079  
Shadow Snapper!



# CRUSTACEAN BUILDING STEPS!

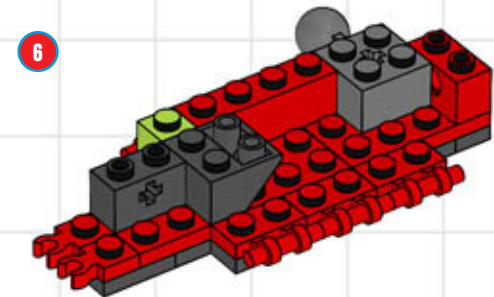
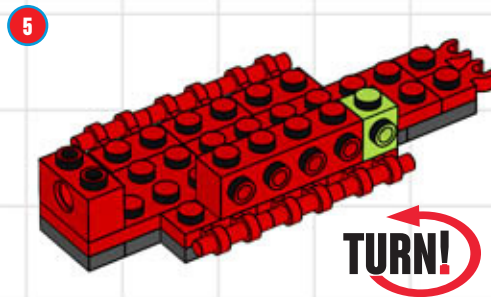
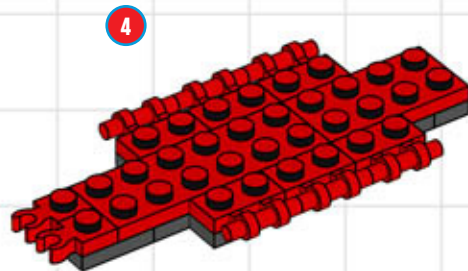
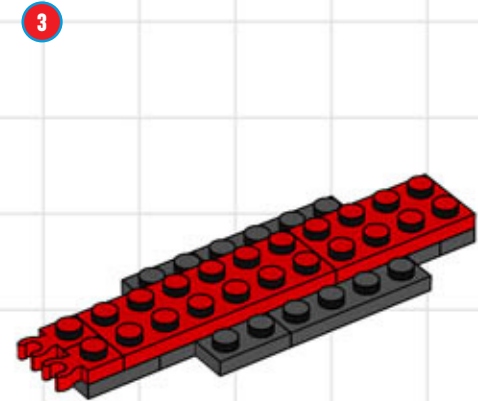
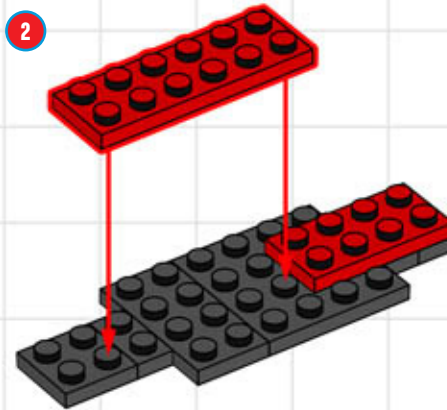
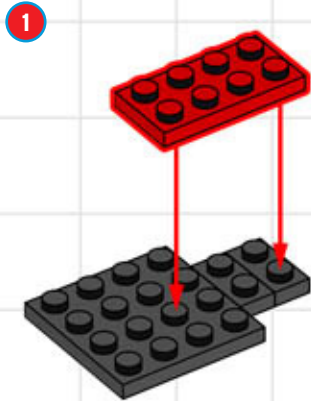

# CRUSTACEAN BUILDING STEPS!



7

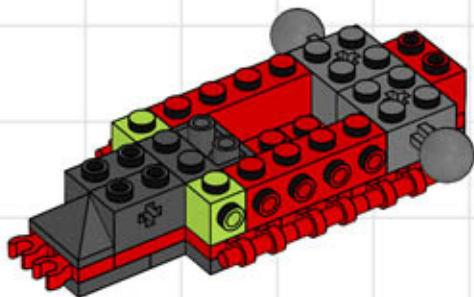

8

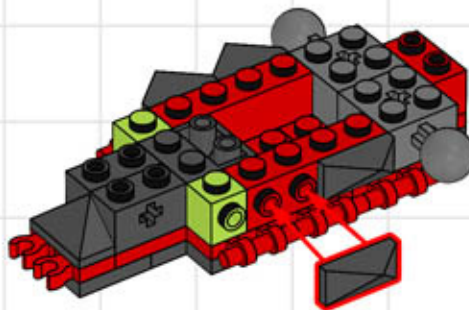

9

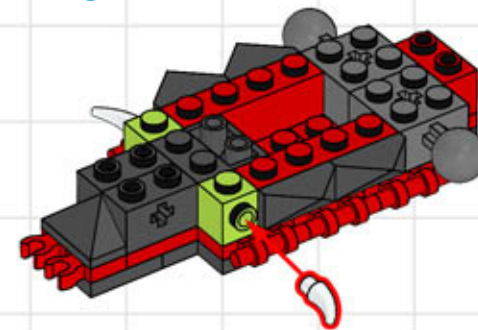

10

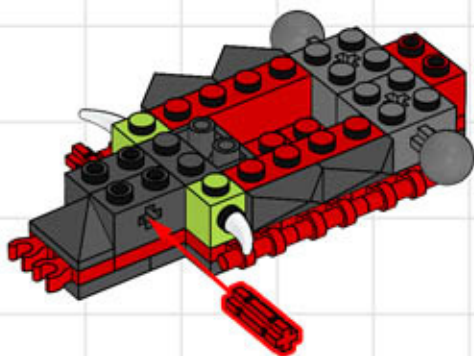

11

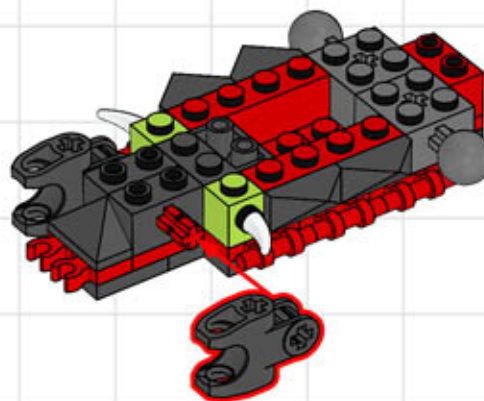

12

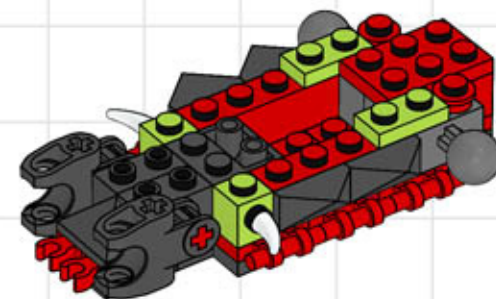

# CRUSHTACEAN BUILDING STEPS!

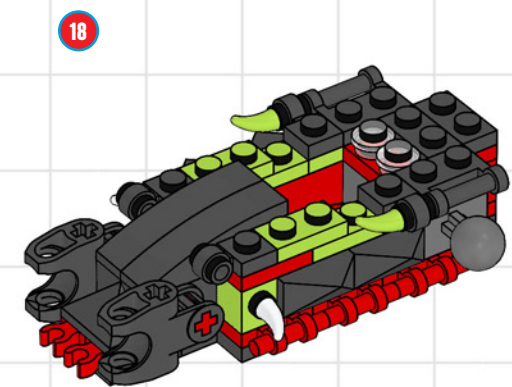
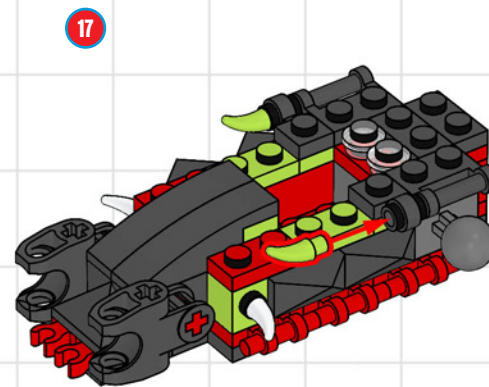
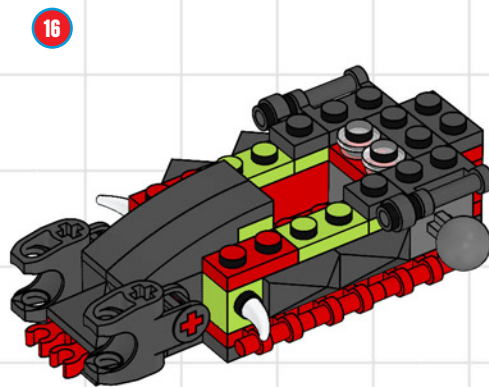
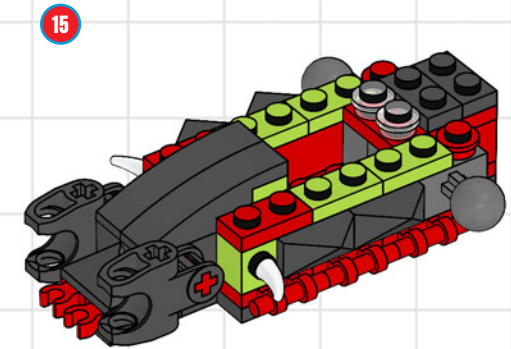
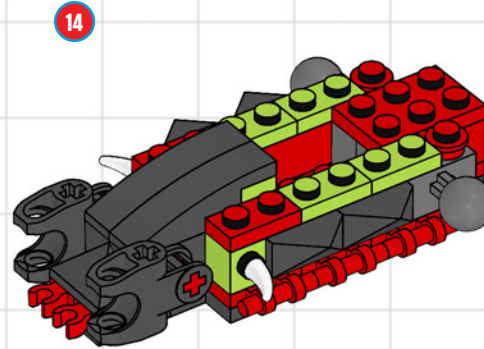
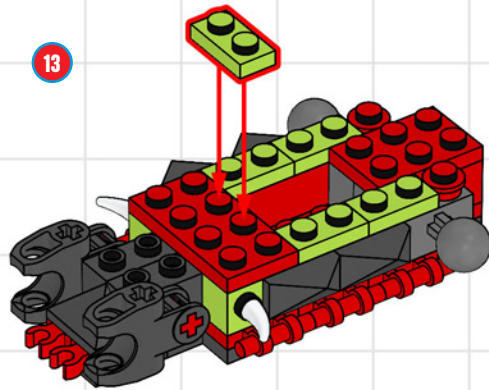

# CRUSHTACEAN BUILDING STEPS!



19

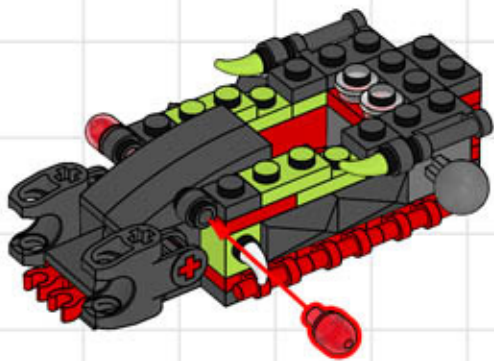

20

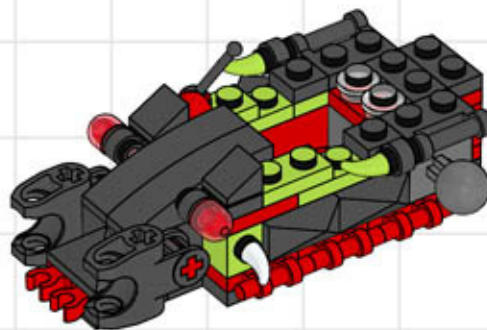

21

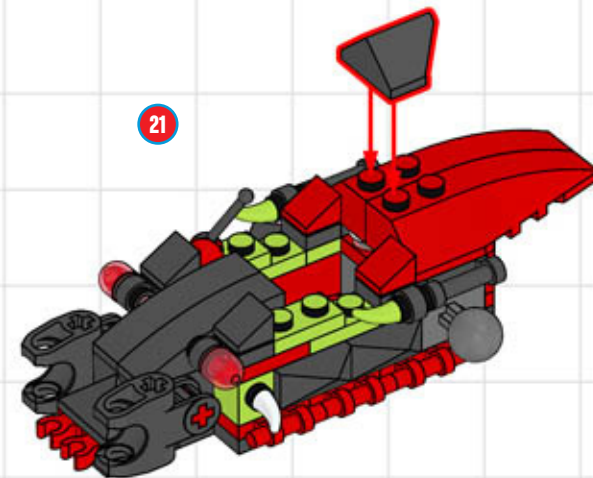

22.1



22.2

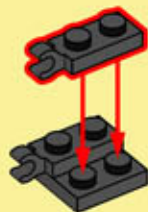

22.3



x2

22

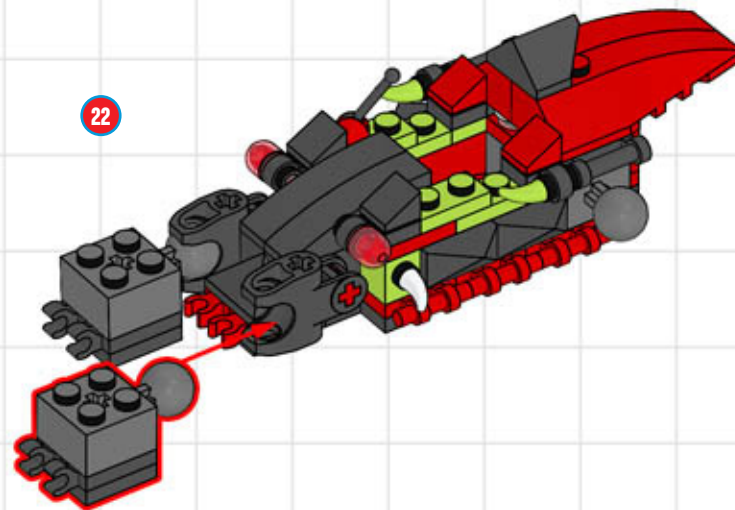

# CRUSTACEAN BUILDING STEPS!

23

FLIP

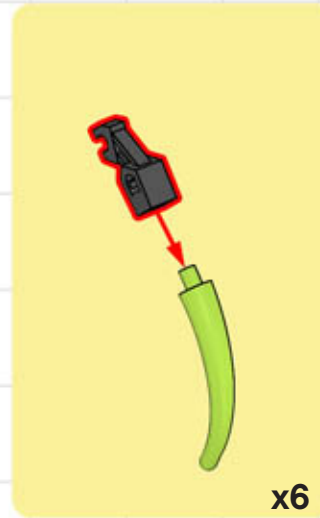
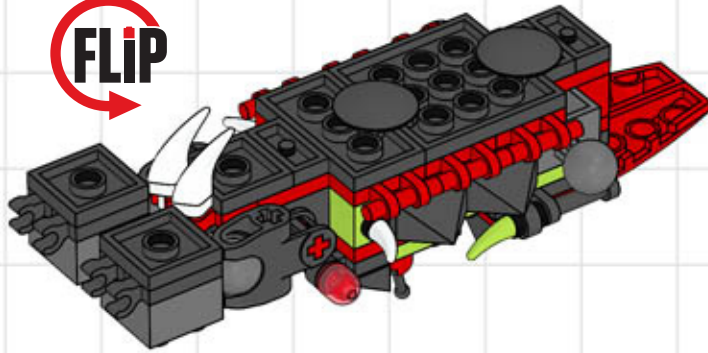

24

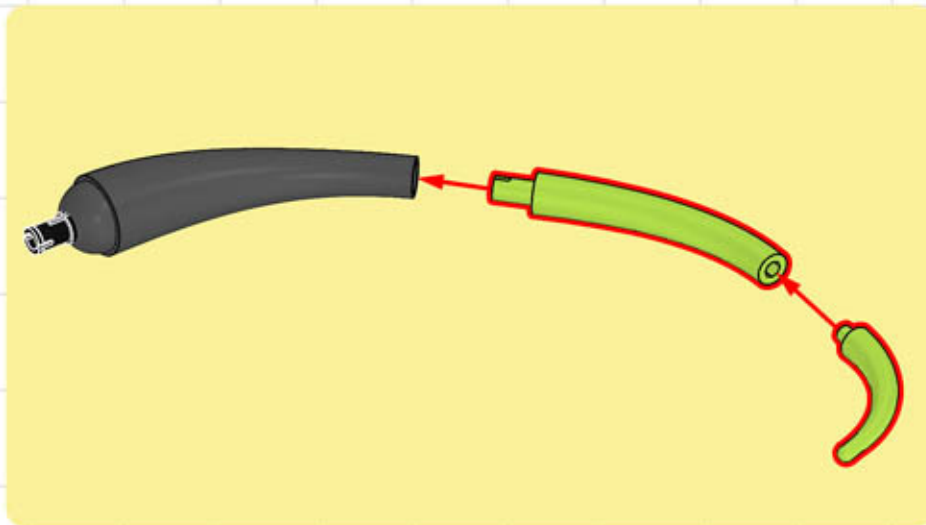
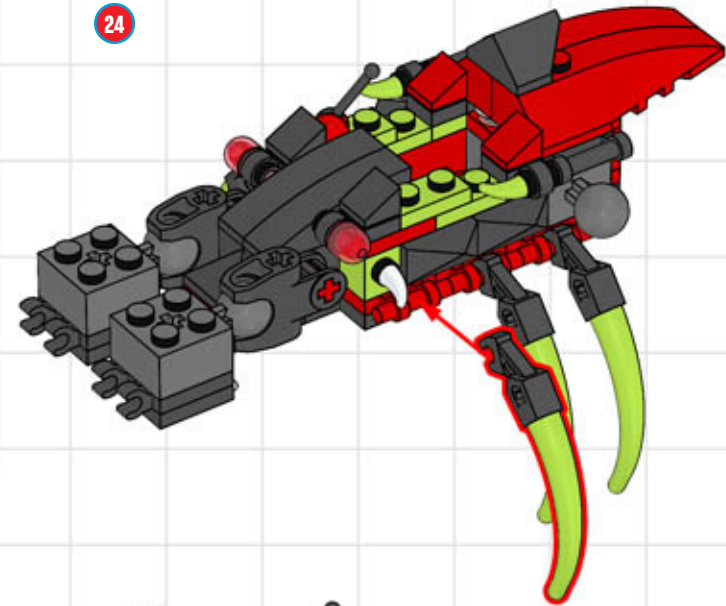

25

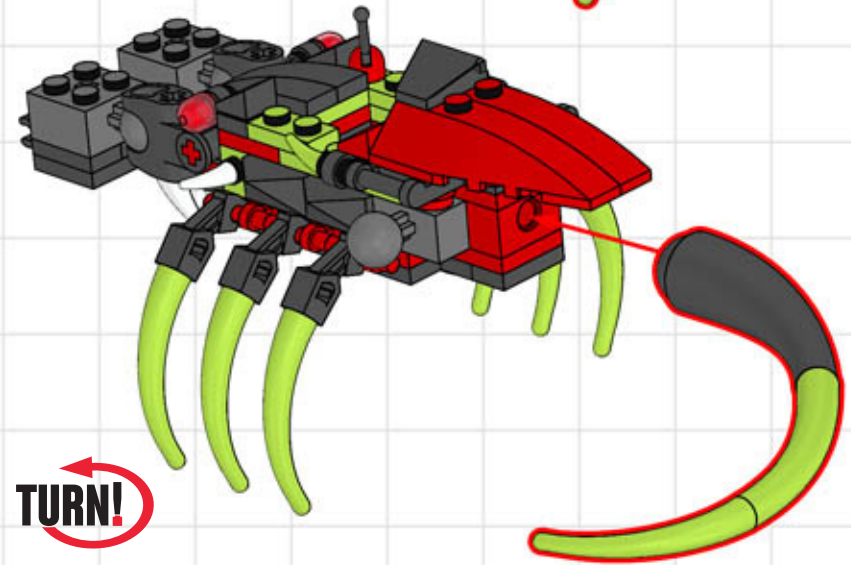

# CRUSHTACEAN BUILDING STEPS!

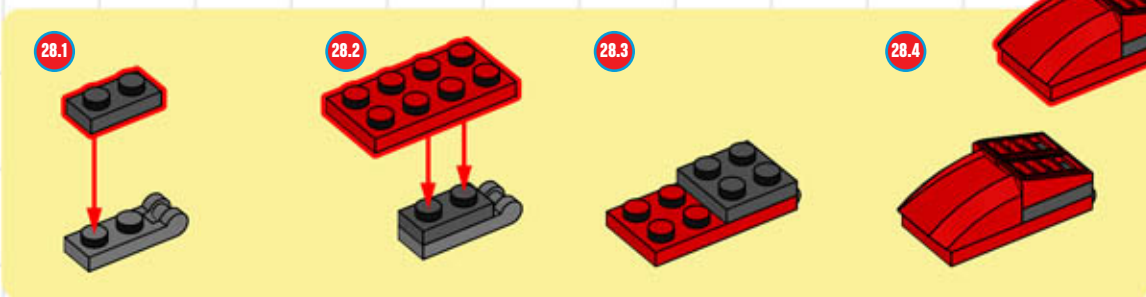
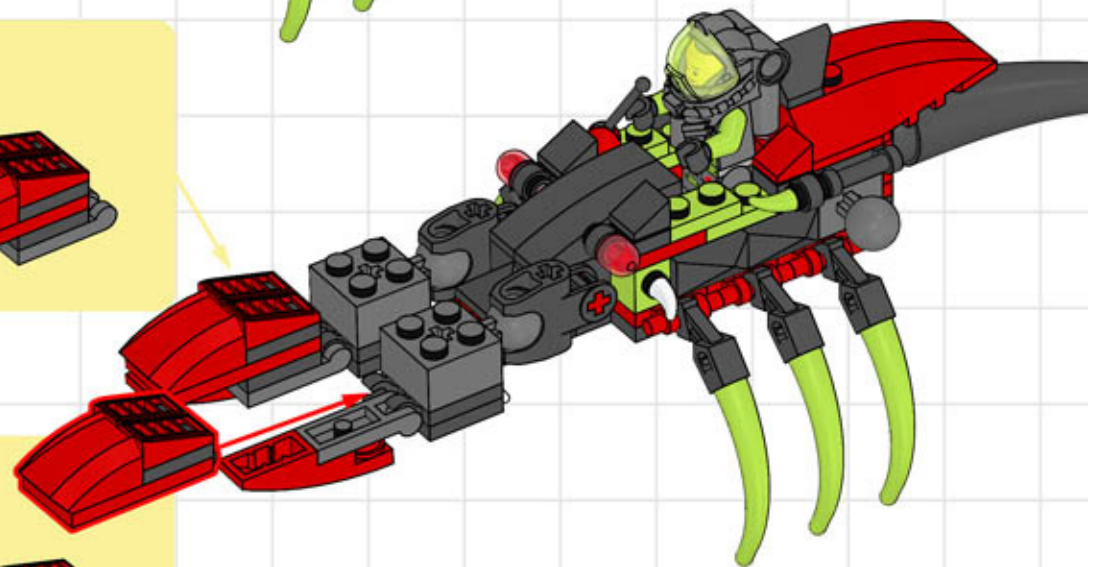
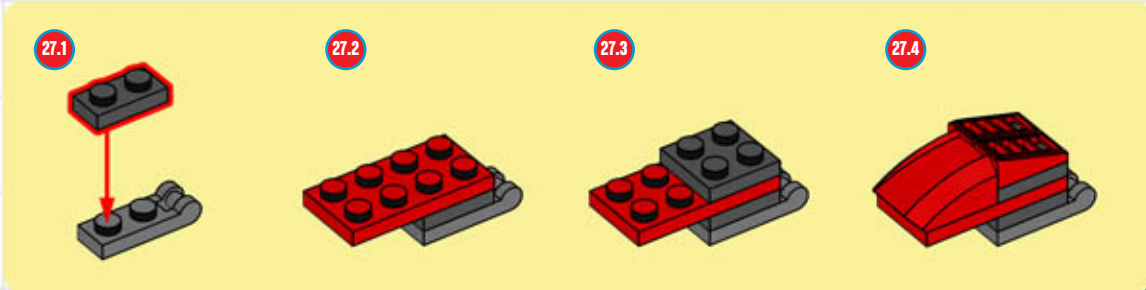
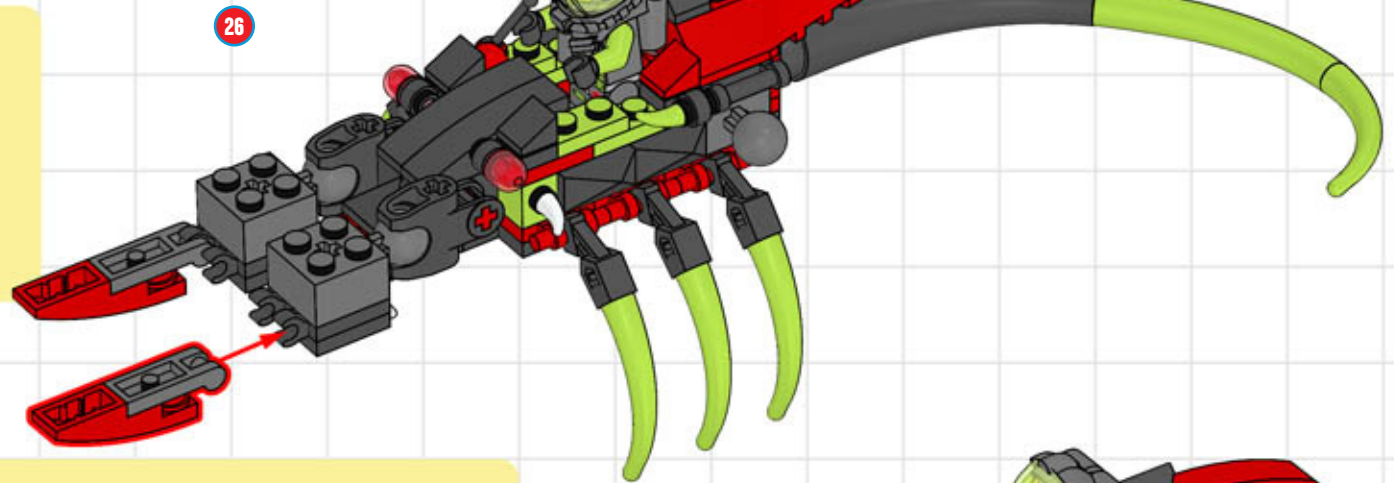
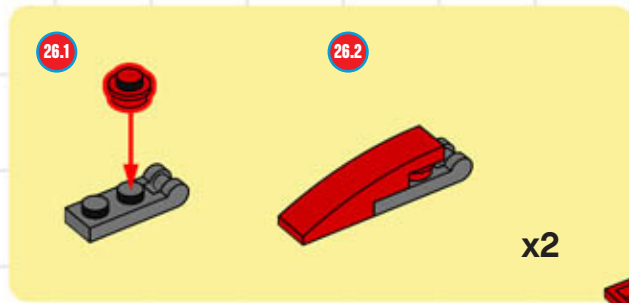

# CRUSHTACEAN BUILDING STEPS!



FINAL

