

MARS MODEL!

BUILDING STEPS

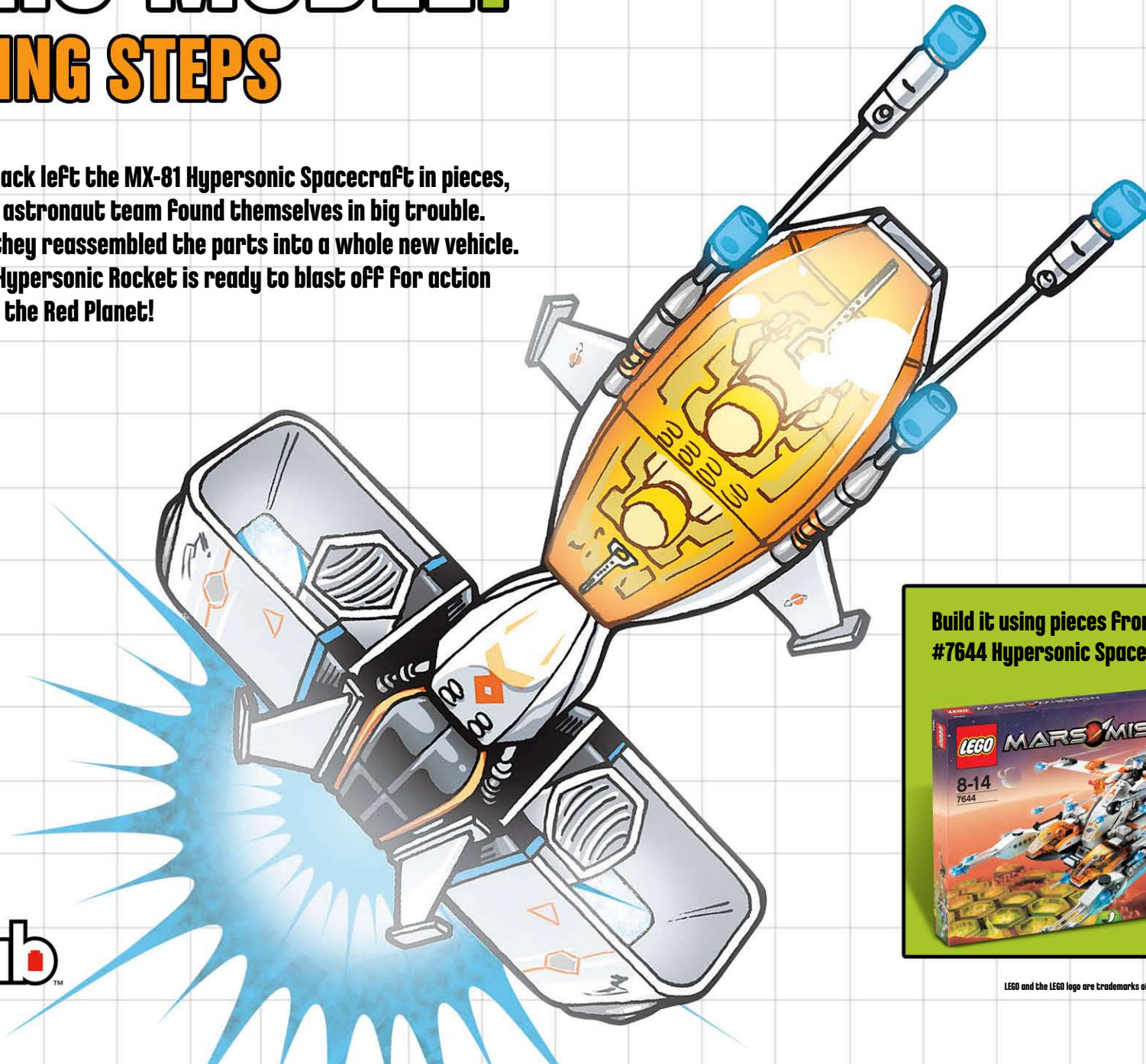

When an alien attack left the MX-81 Hypersonic Spacecraft in pieces, the Mars Mission astronaut team found themselves in big trouble. Building quickly, they reassembled the parts into a whole new vehicle. Now the MX-81-A Hypersonic Rocket is ready to blast off for action and adventure on the Red Planet!



Build it using pieces from
#7644 Hypersonic Spacecraft!



LEGO club MARS MODEL!

BUILDING STEPS

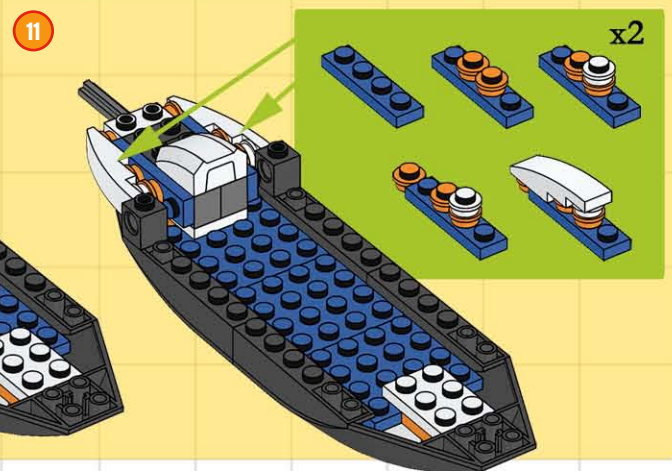
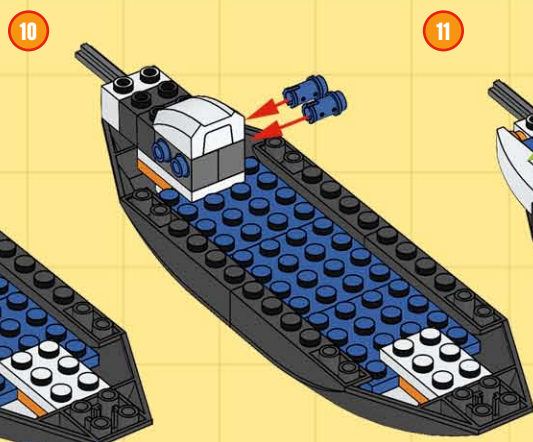
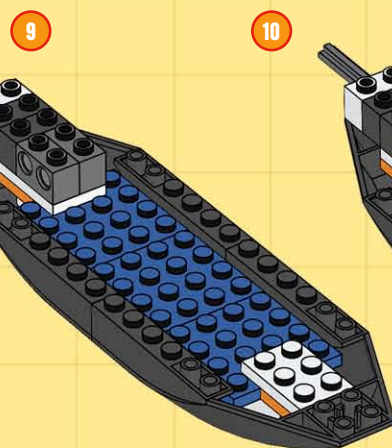
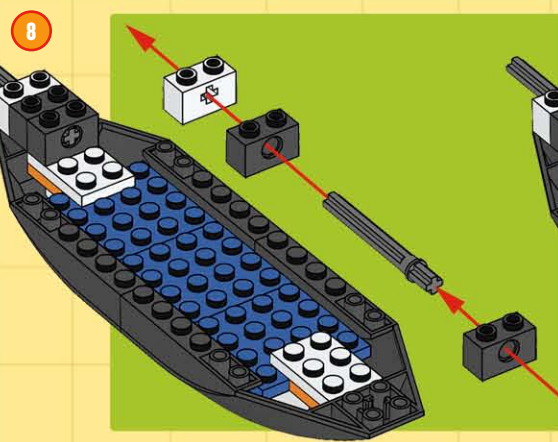
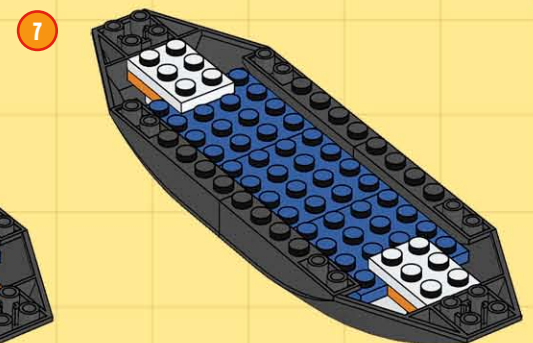
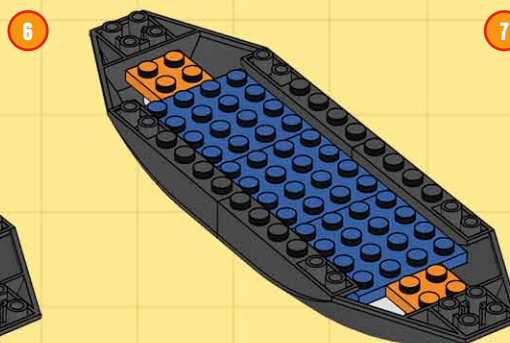
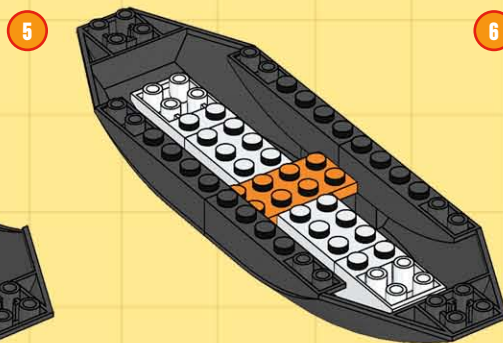
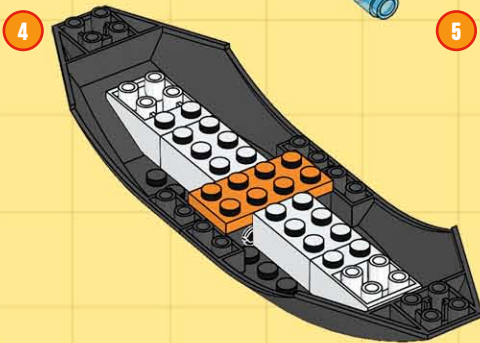
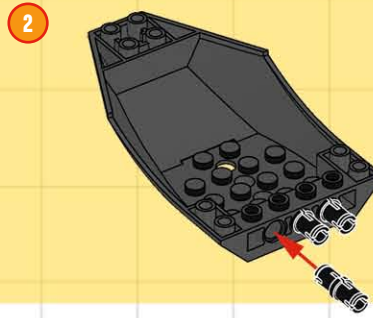
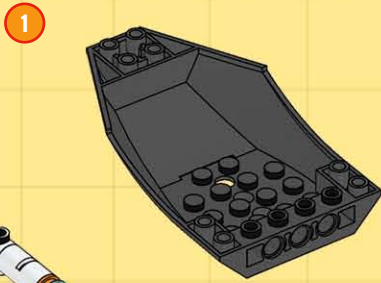

LEGO club MARS MODEL!
BUILDING STEPS



12

13

14

15

16

17

18

19

20

LEGO club MARS MODEL!
BUILDING STEPS

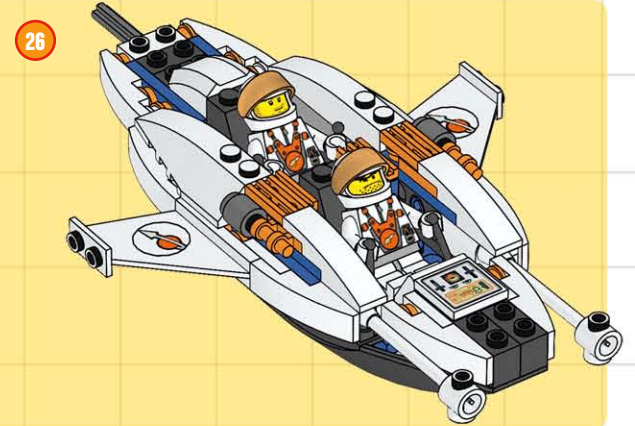
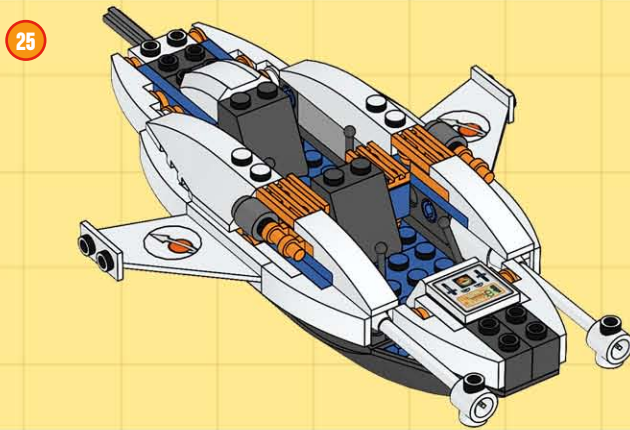
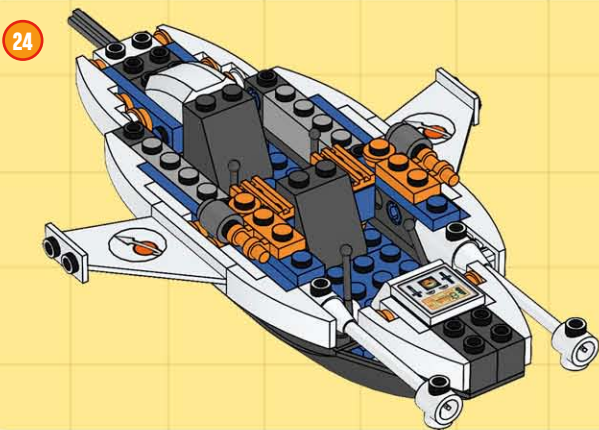
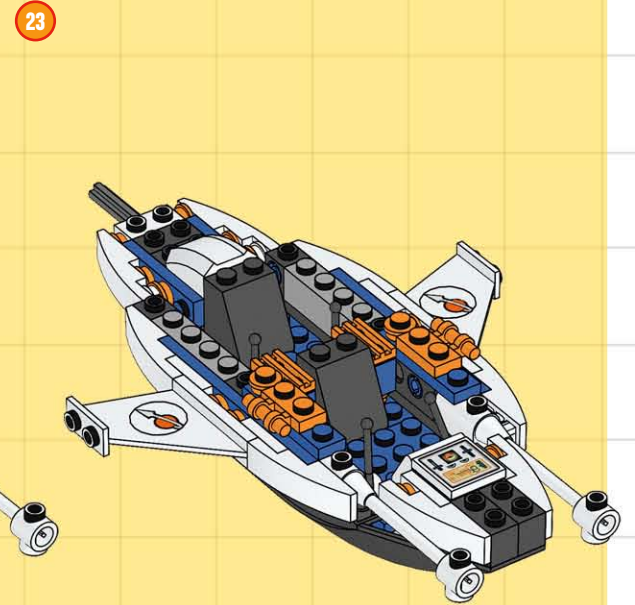
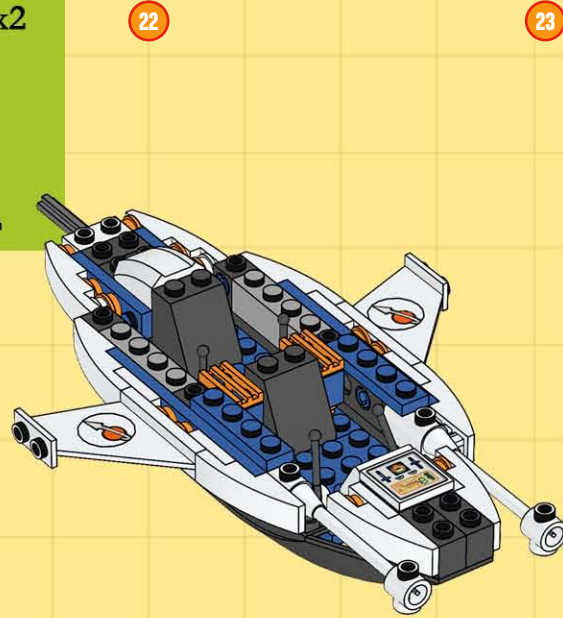
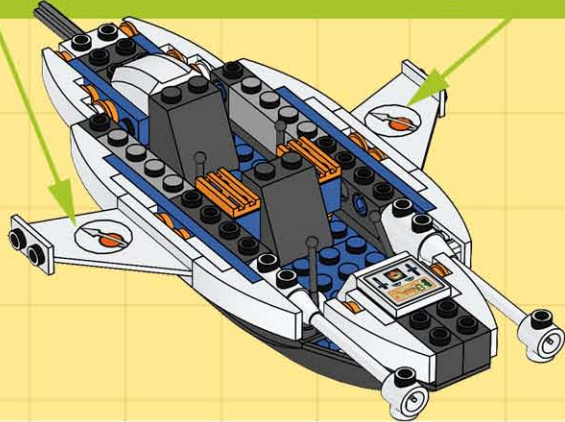
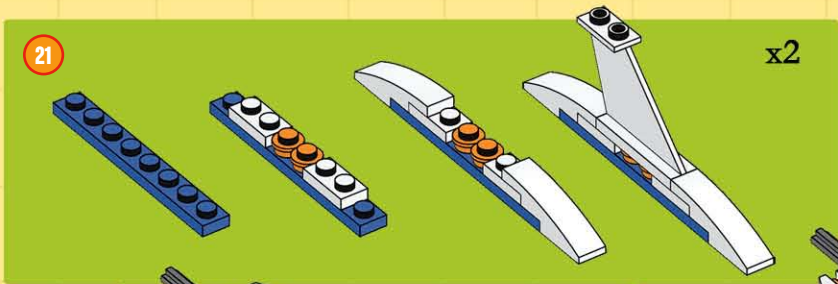

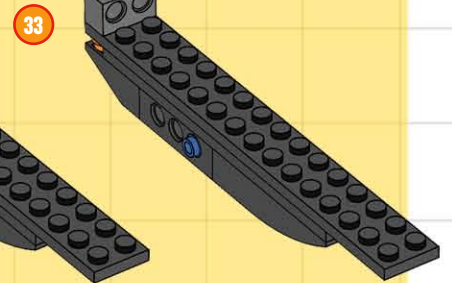
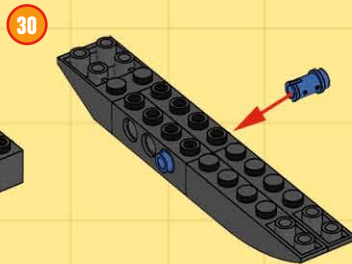
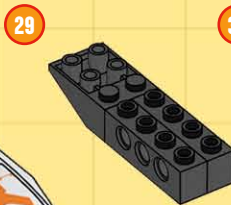
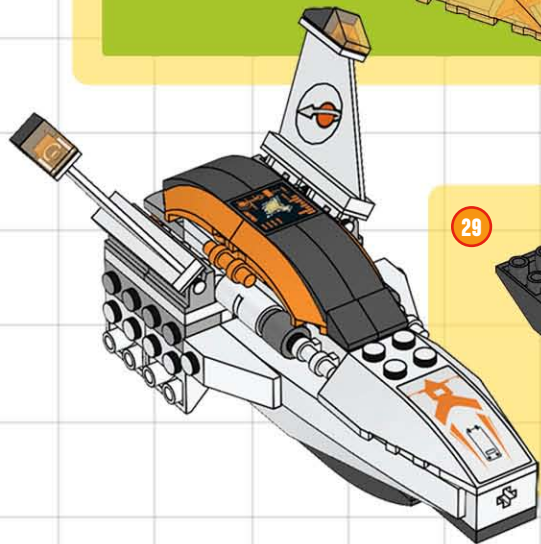
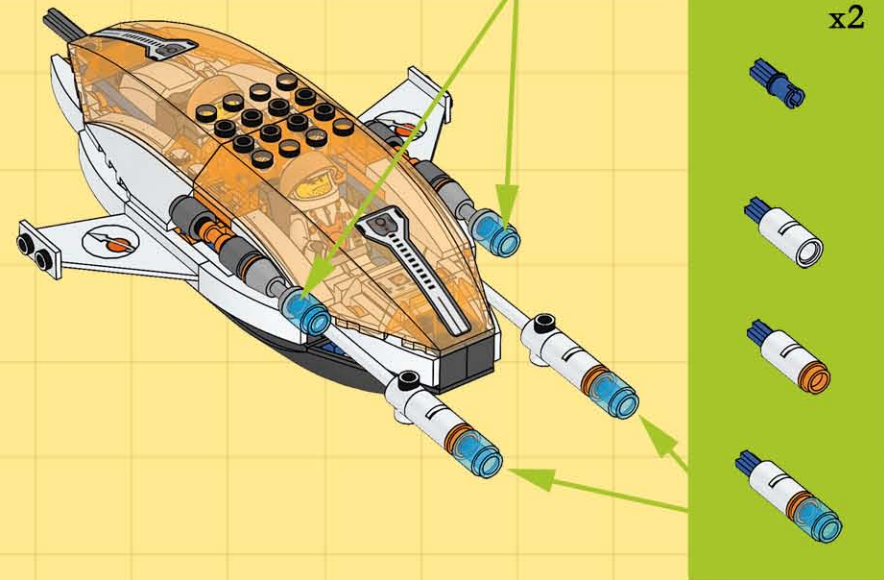
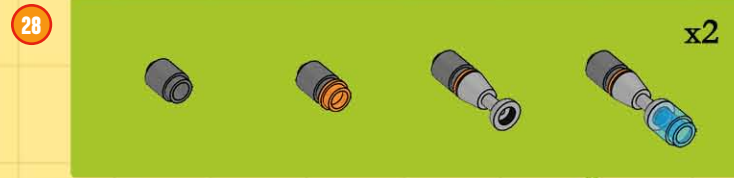
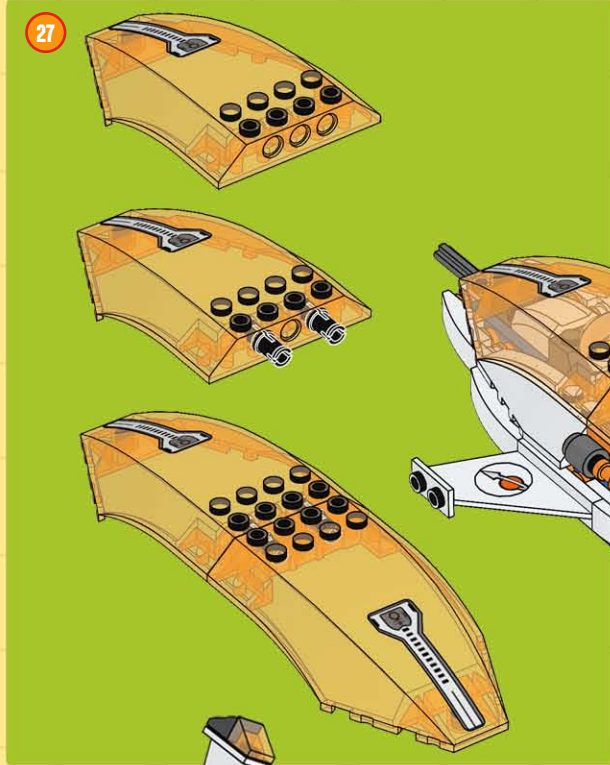

LEGO club MARS MODEL!
BUILDING STEPS



34

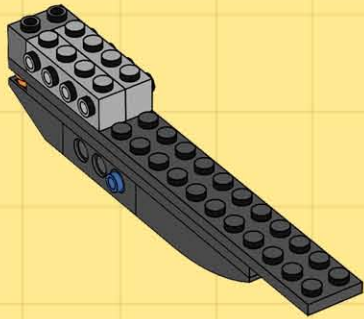

35

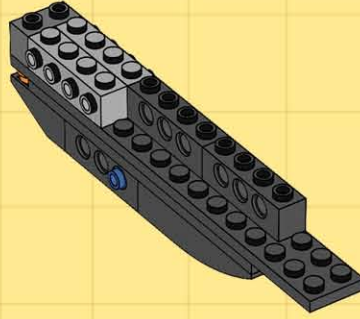

36

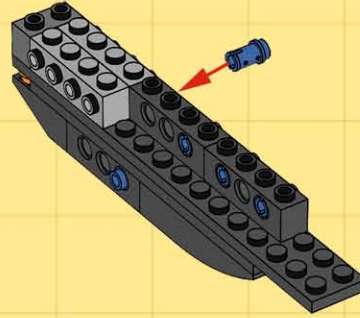

37

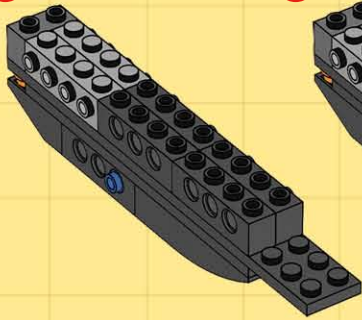

38

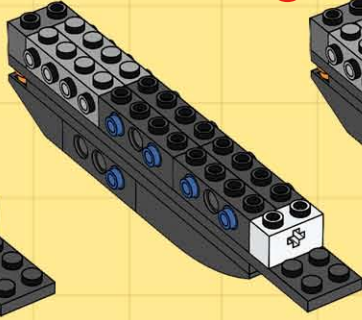

39

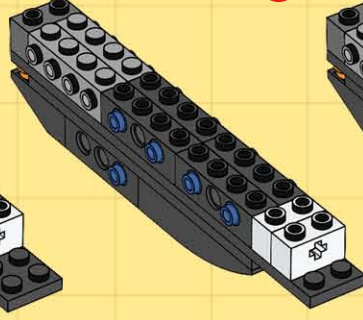

40

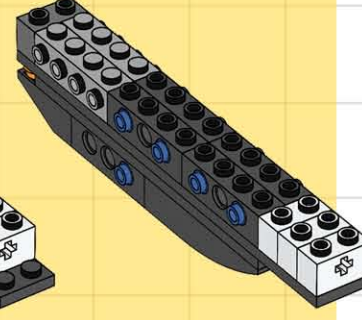

41

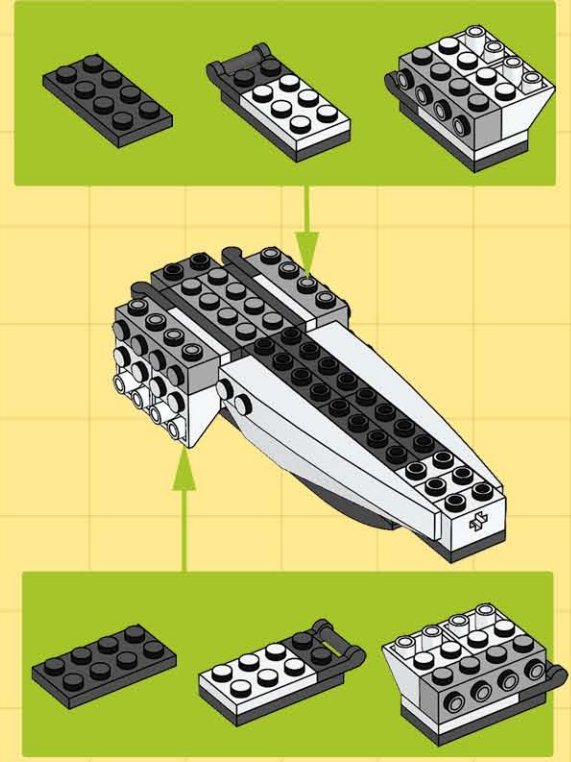

42

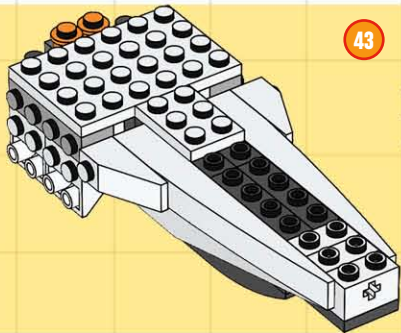

43

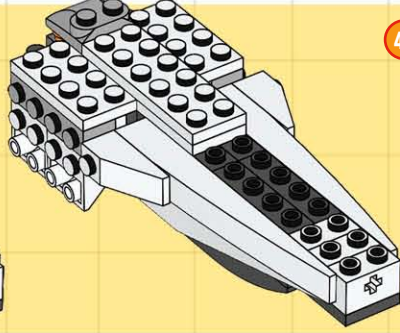

44

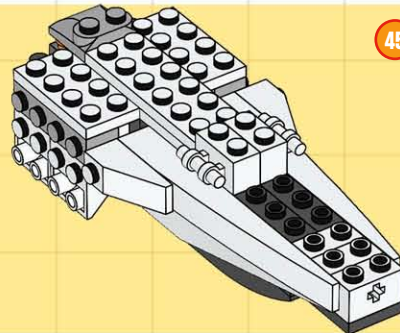

45

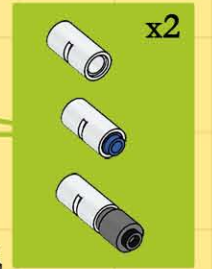
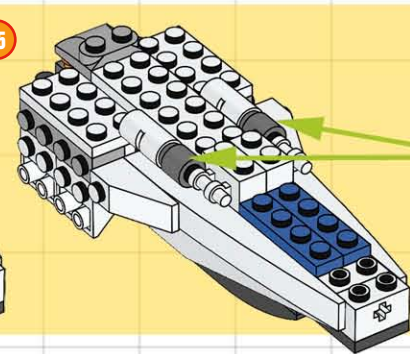

LEGO club MARS MODEL!
BUILDING STEPS

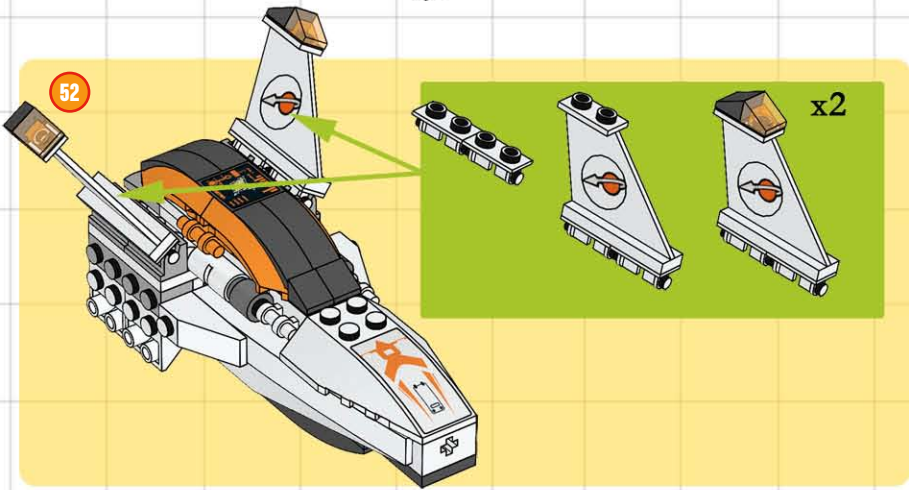
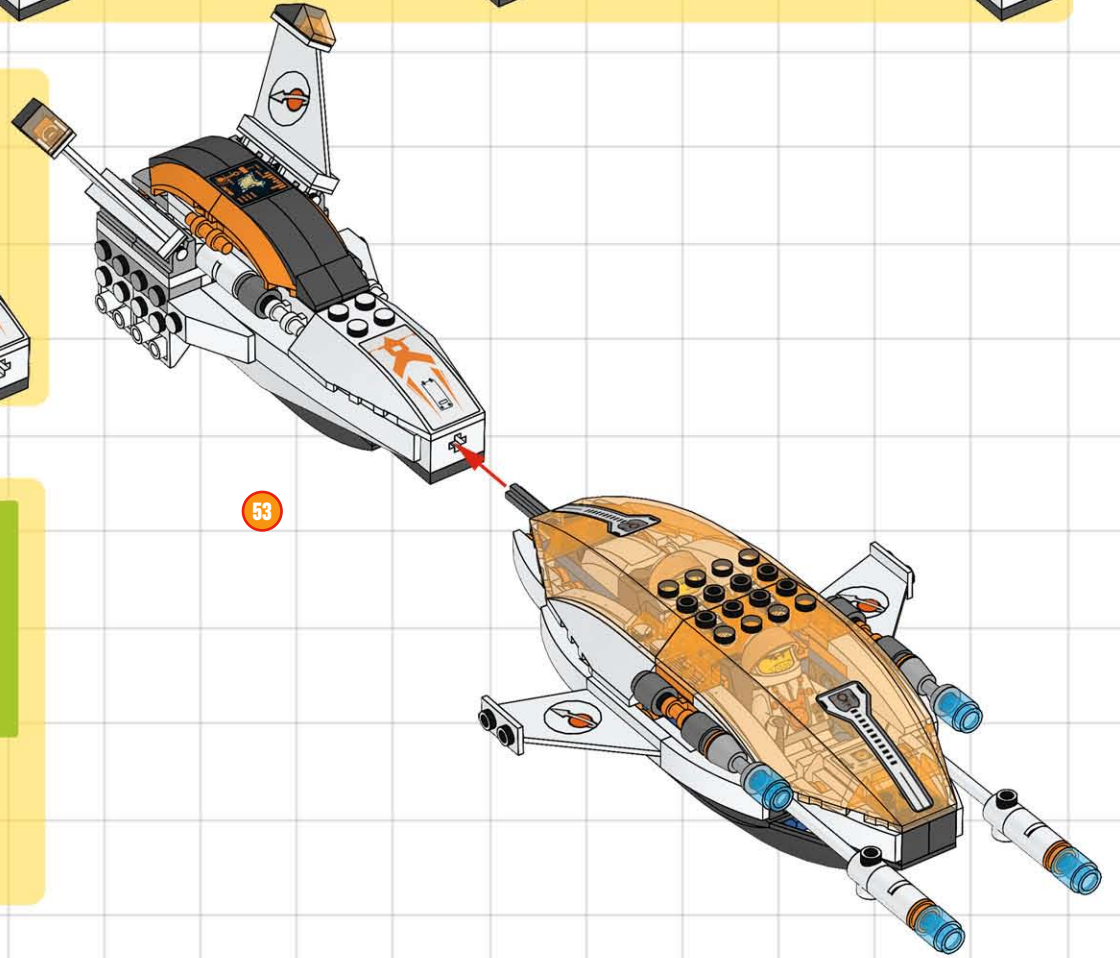
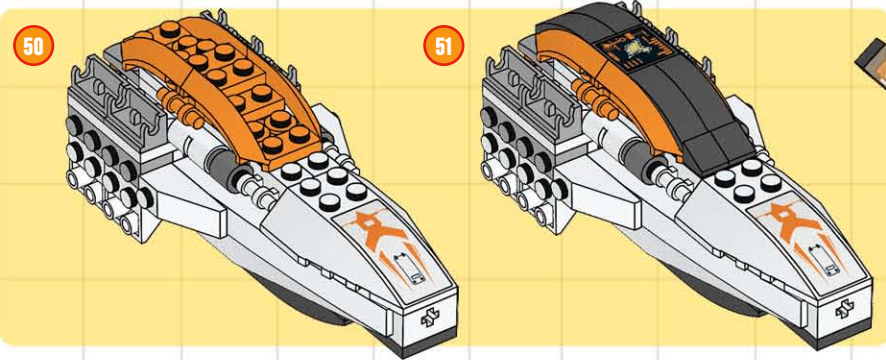
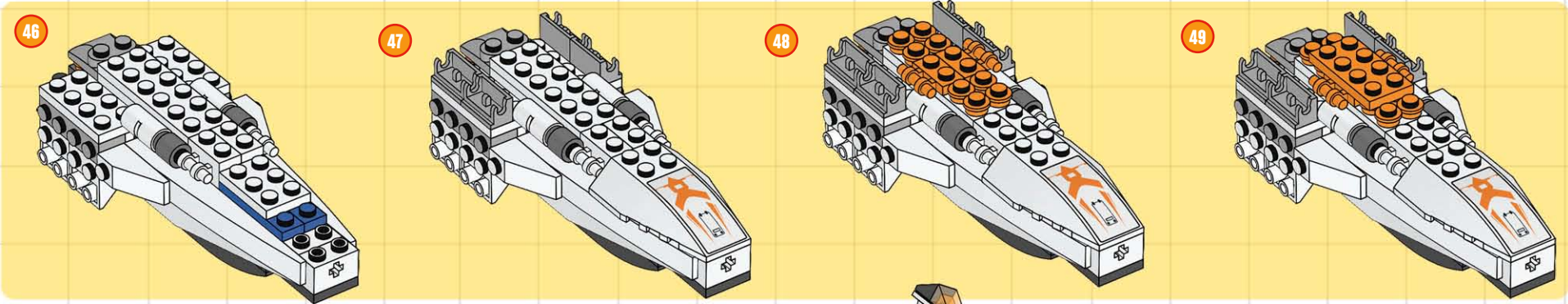

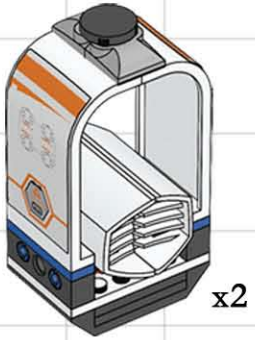

54

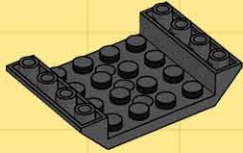

55

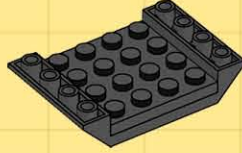

56



57



58



59



60



61

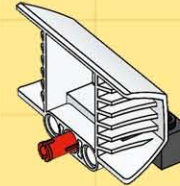

62

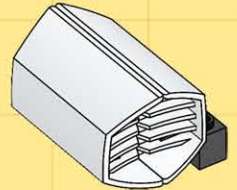

63

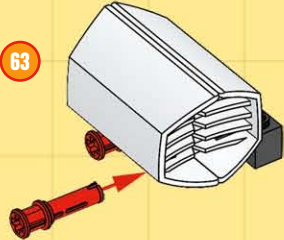

64

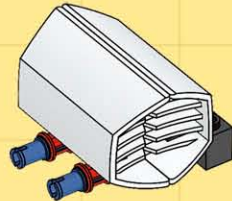

65

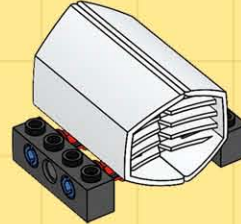

66

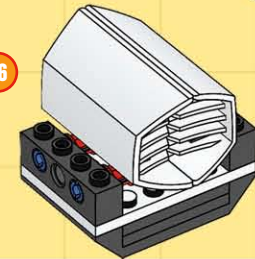

54

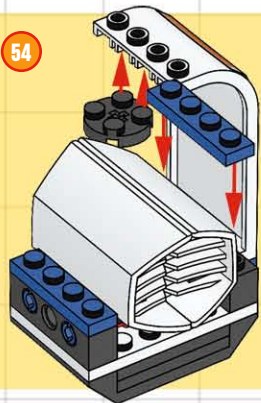

54



54

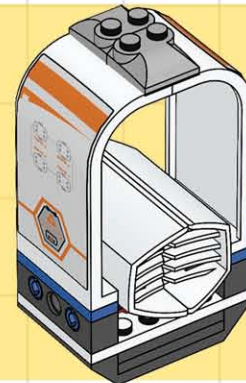

54

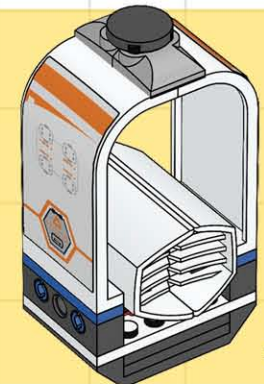

x2

LEGO club MARS MODEL!
BUILDING STEPS

